



Technical Catalog for Professionals

SILVER EDITION

www.clairedeco.com

INDEX

TRADITIONAL ENSEMBLES

ADJUSTABLE ROD KITS - 5/8" - 1/2"	24
ADJUSTABLE ROD KITS - 1" - 7/8"	25
ARTFIL KITS	34
BRASS 1"	31
BRASS 1 1/8"	32
BRASS 1 1/2"	33
CURVED RODS	24
INFINETTE MEDALLIONS	30
METRO 1 1/8"	28
SIMPLICITE	22
WROUGHT IRON 3/4"	26
WROUGHT IRON 1"	27
WROUGHT IRON 1 1/2"	29

BAY WINDOW PROGRAMS

KONTUR EVO	7
INFINETTE	30
SAN FRANCISCO PROGRAM - 5/8" DIAMETER ADJUSTABLE ROD KITS	24
SAN FRANCISCO PROGRAM - 3/4" DIAMETER ADJUSTABLE ROD KITS	26
SIMPLICITE	23

TEKNO FUNCTIONAL ROD SYSTEMS

EURO-SCOPE	4
INVISIBLE	9
KONTUR ALU	8
KONTUR EVO	6
NEXGEN	14
NEXGEN APPLIQUE	15
NEXGEN WOOD	17
TEKNO 25	5
TEKNO 40	16
TEKNO 40 WOOD	12
URBAN 3 & 5	10

TECHNICAL INFORMATION FOR TEKNO PRODUCTS 19 - 21



i **Hidden Tab Tape** creates an undulating appearance with minimal work. See page 3 for product codes.



i **California Pleat Tape** creates a unique knife edge pleat. See page 3 for product codes.

WAVE DRAPE • TEKNO WAVE, STANDARD WAVE & TEKNO SNAP

Wave Drape carriers use a unique hook system as opposed to the traditional snaps.

- Wave Hooks allow for more flexibility and ease of use.
- Multiple fullness: 1.8 to 2.7 fullness.
- Easy installation, no force required to place hooks.
- Change hook placements quickly after drape is installed.
- Drapes can be washed even with hooks are installed.

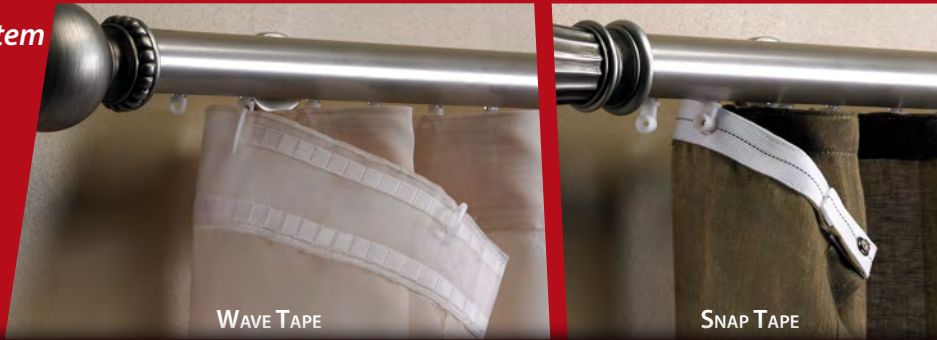

WAVE TAPE

SNAP TAPE

WAVE ADVANTAGE

i Easily compare using our online wave calculator for any rod length. Below we give an example using a 100" rod length comparing 10 versus 12 pocket and 100% versus 80% stacking.

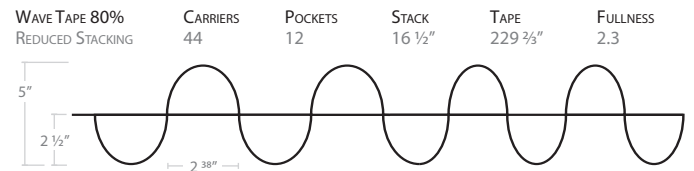
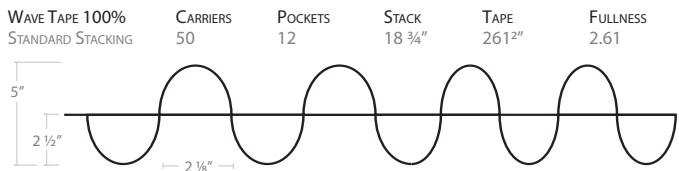
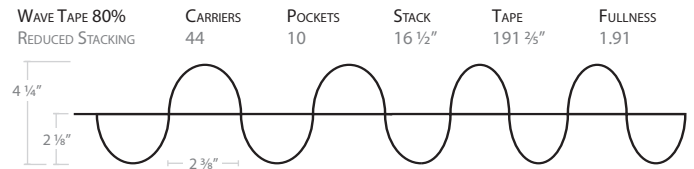
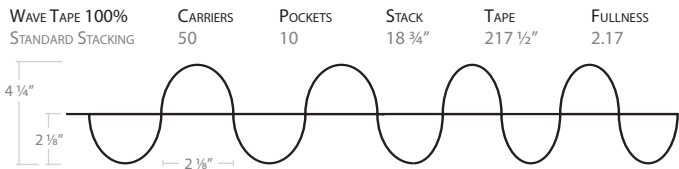

HOOKS, CARRIERS & TAPES

STANDARD WAVE CARRIERS



HMP5180 80%
HMP5060 100%
HMP5140 120%
Hooks included

TEKNO WAVE CARRIERS



HMP5380 80%
HMP5330 100%
HMP5350 120%
Hooks included

DELUXE WAVE CARRIER



HMP5500-W
Only for Nexgen, Nexgen Wood and Tekno 40 rails

STANDARD SNAP CARRIERS



HMP5080 80%
HMP5200 100%
HMP5120 120%

TEKNO SNAP CARRIERS



HMP5480 80%
HMP5310 100%
HMP5320 120%

OTHER SNAP CARRIERS



HMP5300-W
FRONT LOAD 100%



HMP5540-W
DELUXE 100% *Only for Nexgen, Nexgen Wood and Tekno 40 rails*



HMP7080
WAVE TAPE
Hooks not included



HMP7070
SNAP TAPE



HMP7060
HIDDEN TAB TAPE



HMP7100
CALIFORNIA PLEAT TAPE



HMP5090
WAVE HOOK

AVAILABILITY CHART

	EURO-SCOPE, TEKNO 25, TEKNO 40 WOOD, KONTUR ALU, URBAN 3 & 5		KONTUR EVO		TEKNO 40, NEXGEN, NEXGEN WOOD	
	Hand Draw	Corded	Hand Draw	Corded	Hand Draw	*Corded
Standard Wave Carrier	Y	Y	Y	N	Y	Y
Tekno Wave Carrier	Y	Y	N	N	Y	Y
Snap Carrier	Y	Y	Y	N	Y	Y
Tekno Snap Carrier	Y	Y	N	N	Y	Y

***NEXGEN CORDED TRACKS: MASTER CARRIERS WILL BE WITH A REGULAR FLAT OVERLAP.**

i Wave Drape is available for Euro-scope.
See page 3 for product codes and details.
Euro-scope technical diagrams Page 19.

EURO-SCOPE



HAND DRAW

ENSEMBLE INCLUDES:
RODDING, CLIC GLIDES, AND FLING WAND.

*EXTRA FLING WAND FOR CENTER OPENING
DRAPES IS SOLD SEPARATELY.*



ONE WAY - CORDED

ENSEMBLE INCLUDES:
RODDING, CLIC GLIDES, AND PULLEY.

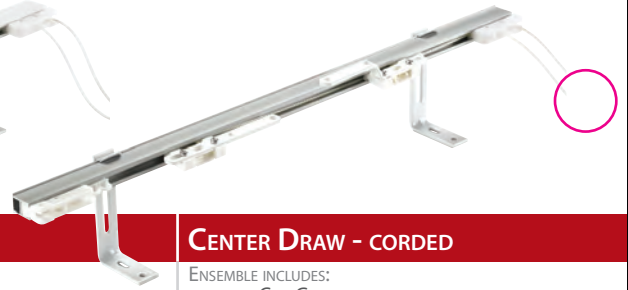

CENTER DRAW - CORDED

ENSEMBLE INCLUDES:
RODDING, CLIC GLIDES, AND PULLEY.

SUPPORT STYLE



HMP6010
CEILING CLIP SUPPORT



HMP6050
SHORT SUPPORT
1 1/4" projection from wall to rod



HMP6040
WALL SUPPORT
2" to 3" projection

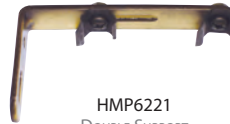

HMP6221
DOUBLE SUPPORT
*1" to 3 1/2" adjustment
between front and back Rods*



HMP6030
LONG SUPPORT
3 3/8" to 4 5/8" projection from wall to rod

Available colors
Rods & supports



AS
ANTIQUÉ SILVER



BR
BRONZE



F
BLACK



W
WHITE

i Rods longer than **106"** will be shipped in two equal lengths. One piece can be requested. Extra shipping charges apply.

Rod length	36"	48"	60"	72"	84"	96"	106"	120"	132"	144"	156"	168"	180"
Clic Glides	12	16	20	24	28	32	36	40	44	48	52	56	60
Supports	2	2	2	3	3	3	4	5	5	5	5	5	5
Splice	0	0	0	0	0	0	0	1	1	1	1	1	1

OPTIONAL PRODUCTS



HMP5340
TEKNO CARRIER
*See chart below
for when to use*



HMP5010
CLIC GLIDE SYSTEM
Glides simply clic into rail



HMP7020
END STOP CLIC
*Adjustable end stop
blocks glides to any position on rail*



HMP7360 - 36"
HMP7480 - 48"
HMP7600 - 60"
HMP7720 - 72"
ALUMINIUM FLING WANDS

AVAILABLE COLORS: BR, DA

COMPATIBILITY

Rod Dimensions	DRAPES WITH : CLIC GLIDES				DRAPES WITH : STANDARD WAVE CARRIER				DRAPES WITH : STANDARD SNAP CARRIER			
	Hand Draw	One Way	Center	Tekno Carriers	Hand Draw	One Way	Center	Tekno Carriers	Hand Draw	One Way	Center	Tekno Carriers
48" - 72"	R	R	R	NR	R	R	R	NR	R	R	R	NR
84" - 96"	R	R	R	S	R	R	R	S	R	R	R	S
106"	R	R	R	S	R	R	R	S	R	R	R	S
120"	R	R	R	S	R	R	R	S	L	L	R	S
132"	L	L	R	S	L	L	R	S	L	L	L	S
144" - 156"	L	L	L	S	L	L	L	S	L	L	L	S
168" - 180"	NR	NR	L	S	NR	NR	NR	S	NA	NA	NA	S

RECOMMENDED LIGHTWEIGHT DRAPES ONLY SUGGESTED FOR HEAVY DRAPES NOT RECOMMENDED NOT AVAILABLE

i Wave Drape is available for Tekno 25.
See page 3 for product codes and details.
Tekno 25 technical diagrams Page 19.

TEKNO 25 • 1 1/8" DIAMETER



HAND DRAW

ENSEMBLE INCLUDES:
RODDING, CLIC GLIDES, AND FLING WAND.
**EXTRA FLING WAND FOR CENTER OPENING
DRAPES IS SOLD SEPARATELY.**

ONE WAY - CORDED

ENSEMBLE INCLUDES:
RODDING, CLIC GLIDES, AND PULLEY.

CENTER DRAW - CORDED

ENSEMBLE INCLUDES:
RODDING, CLIC GLIDES, AND PULLEY.

SUPPORT STYLE

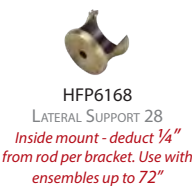

i Rods longer than 106" will be shipped in two equal lengths. One piece can be requested. Extra shipping charges apply.

Rod length	36"	48"	60"	72"	84"	96"	106"	120"	132"	144"	156"	168"	180"
Splice	0	0	0	0	0	0	0	1	1	1	1	1	1
C-Rings	12	16	20	24	28	32	36	40	44	48	52	56	60

FINIALS



BALL 28
HFP0048
3 3/8" L x 2 1/8" DIA.
Shown in Champagne



BLING
HFP0498
2 1/4" L x 1 3/4" DIA.
Shown in Antique Silver



DURAND
HAP0778
3 1/8" L x 2 3/8" DIA.
Shown in Maroon



EMPIRE
HFP0548
7/8" L x 1 5/8" DIA.
Shown in Distressed Wood



JIBOO
HAP0758
3 1/2" L x 2" DIA.
Shown in Antique Silver



LINEA
HFP0568
4" L x 2 1/8" DIA.
Shown in Champagne



OVAL 28
HFP0468
2 1/8" L x 2 1/8" DIA.
Shown in Distressed Wood



TRANS LU
HFP0538
4" L x 2 1/8" DIA.
Shown in Champagne

Available colors
Rods, supports & finials

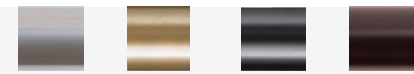

AS ANTIQUE SILVER
CH CHAMPAGNE
DW BLACK
MR MAROON

i Wave Drape is available for **Kontur EVO**.
 See page 3 for product codes and details.
 Kontur EVO technical diagrams Page 19.

KONTUR EVO



HAND DRAW

ENSEMBLE INCLUDES:
 RODDING, CLIC GLIDES, AND FLING WAND.

*EXTRA FLING WAND FOR CENTER OPENING
 DRAPES IS SOLD SEPARATELY.*

ONE WAY - CORDED

ENSEMBLE INCLUDES:
 RODDING, CLIC GLIDES, AND PULLEY.

CENTER DRAW - CORDED

ENSEMBLE INCLUDES:
 RODDING, CLIC GLIDES, AND PULLEY.

SUPPORT STYLE

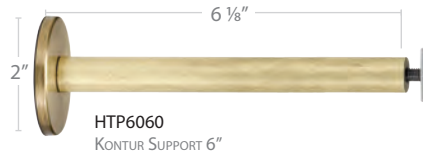

i Rods longer than **106"** will be shipped in two equal lengths. One piece can be requested. Extra shipping charges apply.

Rod length	36"	48"	60"	72"	84"	96"	106"	120"	132"	144"	156"
Hand Draw	0	0	0	0	0	0	0	*1	*1	*1	*1
One Way	0	0	0	0	0	0	0	N/A	N/A	N/A	N/A
Center Draw	0	0	0	0	0	0	0	1	1	1	1

**HAND DRAWN RODS, WHICH ARE SHIPPED IN TWO PIECES, CAN ONLY BE USED AS A CENTER OPENING.*

ROD COLORS



BW
BARN WOOD



CS
CASSIS



CL
CHOCOLATE



E
EBONY



I
IVORY



MC
MONACO



SM
SMOKE



TR
TRUFFLE



WE
WENGE



WF
WINTER

KONTUR EVO

FINIALS



Available colors
Endcaps, Overture & Flex corner

HTP0010 - ENDCAP
HTP0040 - OUVERTURE (PAIR)



HTP0110
KONTUR CENTER CAP
For rods greater than 106" the Center Cap is included automatically.
Center Caps can be ordered separately for inside installations, as a finial.

SHOWN WITH OUVERTURE FINIAL



RETURNS

FLEX CORNER
HTP0160

Allows flexibility in corners.
Adjustable from 10° to 80°.



QUADRA

HTP0092 - QUADRA 2
HTP0094 - QUADRA 4
HTP0096 - QUADRA 6

Return determined by size of support;
Kontur Support 2", 4" & 6"
Each return adds 1/4" to rod length.

AVAILABLE COLORS: AS, DW



HTP0120

REVERSE CORNER

Sold as ensembles with choice of support.
See price-list for ordering instructions.



KONTUR RETURN

HTP0112 - KONTUR RETURN 2
HTP0114 - KONTUR RETURN 4
HTP0116 - KONTUR RETURN 6

Return determined by size of support;
Kontur Support 2", 4" & 6"
Each return adds 1" to rod length.



Available colors
Quadra returns



AS
ANTIQUÉ SILVER



DW
BLACK

i Wave Drape is available for Kontur ALU.
See page 3 for product codes and details.
Kontur ALU technical diagrams Page 19.

KONTUR ALU



HAND DRAW

ENSEMBLE INCLUDES:
RODDING, CLIC GLIDES, AND FLING WAND.

*EXTRA FLING WAND FOR CENTER OPENING
DRAPES IS SOLD SEPARATELY.*

ONE WAY - CORDED

ENSEMBLE INCLUDES:
RODDING, CLIC GLIDES, AND PULLEY.

CENTER DRAW - CORDED

ENSEMBLE INCLUDES:
RODDING, CLIC GLIDES, AND PULLEY.

SUPPORT STYLE

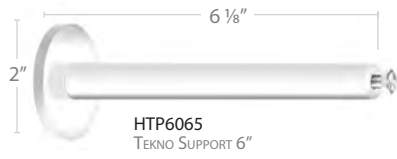
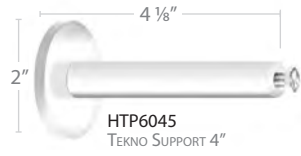

*OVERTURE FINIAL -
DRAPE ABUTS TO THE WALL
ELIMINATING LIGHT GAPS*

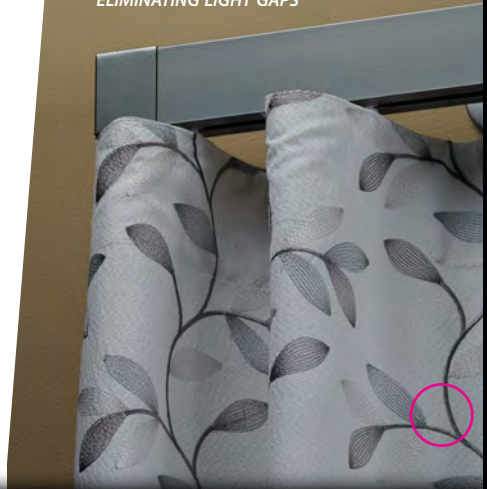

FINIALS



RETURNS

QUADRA
HTP0092 - QUADRA 2
HTP0094 - QUADRA 4
HTP0096 - QUADRA 6
*Return determined by size of support;
Kontur Support 2", 4" & 6"
Each return adds 1/4" to rod length.*



ALU RETURN
HTP0082 - ALU RETURN 2
HTP0084 - ALU RETURN 4
HTP0086 - ALU RETURN 6
*Return determined by size of support;
Kontur Support 2", 4" & 6"
Each return adds 1" to rod length.*



AS
ANTIQUÉ SILVER

DW
BLACK

OB
OIL RUBBED BRONZE

TA
TAUPE

INVISIBLE

i Wave Drape is available for Invisible.
See page 3 for product codes and details.
Invisible technical diagrams Page 20.



HAND DRAW

ENSEMBLE INCLUDES:
RODDING, CLIC GLIDES, FLING WAND AND ENDCAP.
*EXTRA FLING WAND FOR CENTER OPENING
DRAPES IS SOLD SEPARATELY.*

ONE WAY - CORDED

ENSEMBLE INCLUDES:
RODDING, CLIC GLIDES, PULLEY AND ENDCAP.

CENTER DRAW - CORDED

ENSEMBLE INCLUDES:
RODDING, CLIC GLIDES, PULLEY AND ENDCAP.

SUPPORT STYLE

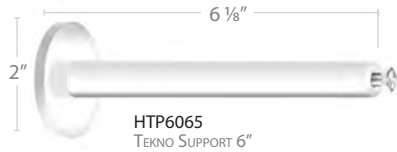
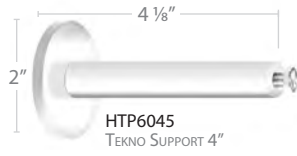

COLORS

Available colors
Rods, supports & finials



UNOBTRUSIVE DESIGN

Invisible Tekno™ System was created to be compact for an unobtrusive design.

A rail installed with an **Invisible Short Projection Support** projects 1 1/2" from the wall.
A rail installed with an **Invisible Simple or Clic Ceiling Support** installs flush to the ceiling with zero light-gap.

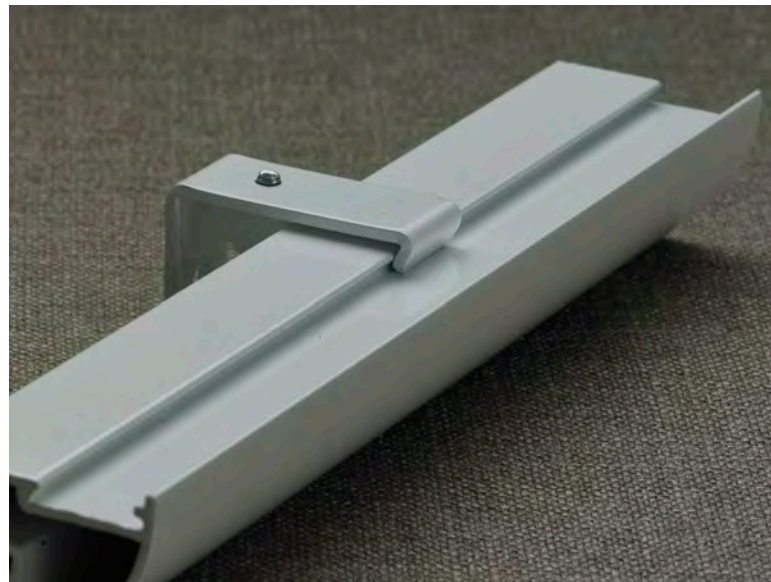

i Factory makes all deductions for the encap

URBAN 3 & URBAN 5

i Wave Drape is available for Urban 3 & 5.
See page 3 for product codes and details.
Urban 3 & 5 technical diagrams Page 20.



VALANCE ONLY

ENSEMBLE INCLUDES:
VALANCE, 2 RETURNS, & SUPPORTS
CEILING SUPPORTS SOLD SEPARATELY.

HAND DRAW

ENSEMBLE INCLUDES:
VALANCE, RETURNS, CLIC GLIDES, FLING WAND & SUPPORTS.
CEILING SUPPORTS SOLD SEPARATELY.
EXTRA FLING WAND FOR CENTER OPENING DRAPES IS SOLD SEPARATELY.

CORDED SYSTEMS

ENSEMBLE INCLUDES:
VALANCE, RETURNS, CLIC GLIDES, PULLEY & SUPPORTS.
CEILING SUPPORTS SOLD SEPARATELY.

VALANCE ENSEMBLES



URBAN 5 WITH RETURN 3
SHOWN IN DULL ARGENTO (DA)
RETURN SIZE: 3" LENGTH X 5" HEIGHT X 1/4" WIDTH



HUP6030
SUPPORT U-3
2 1/4" interior projection, from wall to valance.

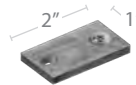

HUP6080
URBAN CEILING SUPPORT
Available with all kits.



URBAN 3 WITH RETURN 3
SHOWN IN BLACK (DW)
RETURN SIZE: 3" LENGTH X 3" HEIGHT X 1/4" WIDTH



URBAN 5 WITH RETURN 5.5
SHOWN IN DULL ARGENTO (DA)
RETURN SIZE: 5 1/2" LENGTH X 5" HEIGHT X 1/4" WIDTH



HUP6050
SUPPORT U-5.5
5 7/8" interior projection, from wall to valance.

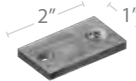

HUP6080
URBAN CEILING SUPPORT
Available with all kits.



URBAN 3 WITH RETURN 5.5
SHOWN IN BLACK (DW)
RETURN SIZE: 5 1/2" LENGTH X 3" HEIGHT X 1/4" WIDTH



URBAN 5 WITH RETURN 7.5
SHOWN IN DULL ARGENTO (DA)
RETURN SIZE: 7 1/2" LENGTH X 5" HEIGHT X 1/4" WIDTH



HUP6070
SUPPORT U-7.5
6 7/8" interior projection, from wall to valance.

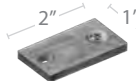

HUP6080
URBAN CEILING SUPPORT
Available with all kits.



URBAN 3 WITH RETURN 7.5
SHOWN IN BLACK (DW)
RETURN SIZE: 7 1/2" LENGTH X 3" HEIGHT X 1/4" WIDTH

i Valance and returns are available in two colors: DA, DW



Available colors
Valance: complete list below
Returns: DA, DW

COLORS



PAINTABLE SURFACE



AH
ASH



AU
AUTUMN



BD
BEACHWOOD



BC
BÉCHAMEL



CF
CAFÉ



DU
DUNE



LT
LATITUDE



MY
MYSTIQUE



RV
RIVA



SV
SILVA



TB
TIMBER



CV
CANVAS

URBAN COMBINATIONS



SINGLE WAVE - VALANCE ROD



SINGLE WAVE - VALANCE



DOUBLE WAVE



SINGLE PLEATED DRAPE - VALANCE ROD



SINGLE PLEATED DRAPE - VALANCE



DOUBLE PLEATED DRAPE

WHEN USING URBAN 3, ENSURE PLEATS DO NOT EXTEND BELOW VALANCE.



SINGLE SHADE - VALANCE



SHADE + WAVE

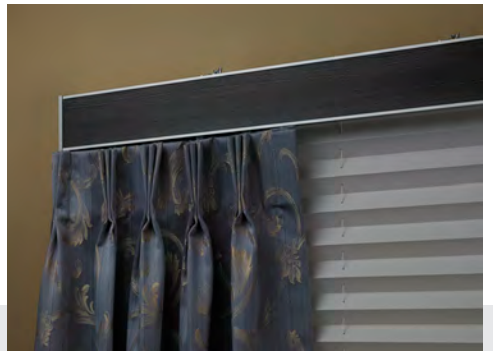

SHADE + PLEATED DRAPE

COMPATIBILITY

CONFIGURATIONS	SPECIAL REQUIREMENTS	3" RETURN	5.5" RETURN	7.5" RETURN	CEILING SUPPORT (For all Return lengths)
Single Wave - valance rod	None	Yes	Yes	Best w/ 3 or 5.5" Re.	Yes
Single Wave - valance	Euro/Nexgen Rods	No	Yes	Best w/ 5.5" Return	Yes
Single Pleated Drape - valance rod	None	Yes	Yes	Best w/ 3 or 5.5" Re.	Yes
Single Pleated Drape - valance	Euro/Nexgen Rods	Yes	Yes	Best w/ 3 or 5.5" Re.	Yes
Single Shade Product - valance	1.75" Clearance	Yes (1.75" Clearance)	Yes	Best w/ 5.5" Return	Yes
Double Wave	Euro/Nexgen Rods	No	No	Yes	Yes
Double Pleated Drape	Euro/Nexgen Rods	No	Yes	Best w/ 5.5" Return	Yes
Shade + Wave Product	Verify supports	Yes (1.75" Clearance)	Yes	Best w/ 5.5" Return	Yes
Shade + Pleated Drape	Verify supports	Yes (1.75" Clearance)	Yes	Best w/ 5.5" Return	Yes

TEKNO 40 WOOD • 1 1/2" DIAMETER

i Wave Drape is available for Tekno 40 Wood. See page 3 for product codes and details. Tekno 40 Wood technical diagrams Page 21.

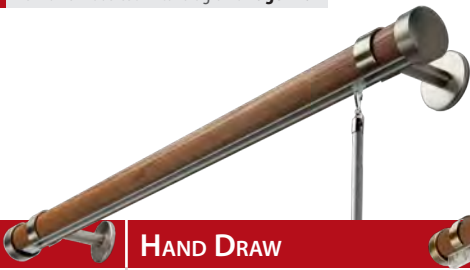

HAND DRAW

ENSEMBLE INCLUDES:
RODDING, CLIC GLIDES, AND FLING WAND.

EXTRA FLING WAND FOR CENTER OPENING DRAPES IS SOLD SEPARATELY.



ONE WAY - CORDED

ENSEMBLE INCLUDES:
RODDING, CLIC GLIDES, AND PULLEY.



CENTER DRAW - CORDED

ENSEMBLE INCLUDES:
RODDING, CLIC GLIDES, AND PULLEY.

SUPPORT STYLE



HFP6164
LATERAL SUPPORT 40
Inside mount -

*deduct 1/4" from rod per bracket.
Use with ROD ONLY ensembles up to 72"*



HTP6014
T40 CEILING SUPPORT



i Rods longer than 106" will be shipped in two equal lengths. One piece can be requested. Extra shipping charges apply.

Rod length	36"	48"	60"	72"	84"	96"	106"	120"	132"	144"	156"
Hand Draw	0	0	0	0	0	0	0	*1	*1	*1	*1
One Way	0	0	0	0	0	0	0	N/A	N/A	N/A	N/A
Center Draw	0	0	0	0	0	0	0	1	1	1	1

**HAND DRAWN RODS WHICH ARE SHIPPED IN TWO PIECES, CAN ONLY BE USED AS A CENTER OPENING.*

TEKNO 40 WOOD • 1 1/2" DIAMETER

ROD COLORS



BW
BARN WOOD

SM
SMOKE

CS
CASSIS

TR
TRUFFLE

CL
CHOCOLAT

WF
WINTER

E
EBONY

T40
TORRIIFIED 40

I
IVORY

T80
TORRIIFIED 80

MC
MONACO

TORRIIFIED WOOD

BRINGING AN AROMATIC FOREST INTO YOUR HOME
CHEMICAL FREE, RICH COLORS & A NATURAL WOOD SMELL
NATURAL KNOTS AND COLOR VARIATIONS MAY APPEAR.

FINIALS & COLORS

HTP0014
TEKNO 40 ENDCAP
1/2" length x 1 5/8" diameter
Shown in Vintage Brass



HTP0304
TEKNO 40 GARIBALDI
3 3/4" length x 2 5/8" diameter
Shown in Antique



A
ANTIQUE

BN
BURNT NICKEL

CR
CHROME

G
GRAPHITE

SH
SAHARA

S
STAINLESS

VB
VINATGE BRASS

i Wave Drape is available for Nexgen.
See page 3 for product codes and details.
Nexgen technical diagrams Page 21.

NEXGEN



HAND DRAW

ENSEMBLE INCLUDES:
RODDING, NEXGEN GLIDES, AND FLING WAND.
*EXTRA FLING WAND FOR CENTER OPENING
DRAPES IS SOLD SEPARATELY.*

ONE WAY - CORDED

ENSEMBLE INCLUDES:
RODDING, NEXGEN GLIDES, AND PULLEY.

CENTER DRAW - CORDED

ENSEMBLE INCLUDES:
RODDING, NEXGEN GLIDES, AND PULLEY.

SUPPORT STYLE



i Rods longer than 106" will be shipped in two equal lengths.
One piece can be requested.
Extra shipping charges apply.

Rod length	36"	48"	60"	72"	84"	96"	106"	120"	132"	144"	156"	168"	180"
Splice	0	0	0	0	0	0	0	1	1	1	1	1	1

Available colors
Rods, supports & optional endcap

COLORS



BR
BRONZE



AS
ANTIQUE SILVER



W
WHITE

HTP0170 NEXGEN ENDCAP

OPTIONAL ENDCAP



BR
BRONZE



AS
ANTIQUE SILVER



W
WHITE

NEXGEN APPLIQUE

i Add colour to your Nexgen for more style and design!



S
STAINLESS

BR
BRUSHED
ALUMINIUM

K
BLACK

C
COPPER

Z
ZEBRANO

AU
AUTUMN

BC
BECHAMEL

E
EBONY

P
PEWTER

R
ROUGE

SM
SMOKE



i Shown on **Bronze** rail. Rail also available in **Antique Silver** and **White**.

i Available with Nexgen and Nexgen Applique

DOUBLE ROD



To create a double rod, order two single rods with quantity of supports needed.



HMP6260
HD DOUBLE ADJUSTABLE
Front Rod :
6 3/4" to 8" adj.
projection (wall to rod)
Back Rod:
5/8" to 2" adj.
projection (wall to rod)



HMP6240
HD DOUBLE SUPPORT
Front Rod :
5" projection (wall to rod)
Back Rod:
5/8" to 2" adj.
projection (wall to rod)

TEKNO 40 • 1 1/2" DIAMETER

i Wave Drape is available for Tekno 40. See page 3 for product codes and details. Tekno 40 technical diagrams Page 21.



HAND DRAW

ENSEMBLE INCLUDES:
RODDING, NEXGEN GLIDES AND FLING WAND
EXTRA FLING WAND FOR CENTER OPENING DRAPES IS SOLD SEPARATELY.



ONE WAY - CORDED

ENSEMBLE INCLUDES:
RODDING, NEXGEN GLIDES AND PULLEY.



CENTER DRAW - CORDED

ENSEMBLE INCLUDES:
RODDING, NEXGEN GLIDES, AND PULLEY.

SUPPORT STYLE



HTP6010
KONTUR CEILING SUPPORT

AVAILABLE COLORS: AS, CH, DW

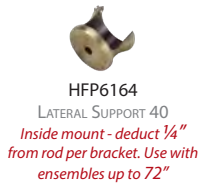

HFP6164
LATERAL SUPPORT 40
Inside mount - deduct 1/4" from rod per bracket. Use with ensembles up to 72"



FINIALS



ARON

HTP0204
4" L X 2 3/8" DIA.
Shown in Sienna



CENTRALIA

HTP0214
3 5/8" L X 2 3/8" DIA.
Shown in Sandal



ELFIN

HTP0284
4" L X 2 3/4" DIA.
Shown in Maroon



GARIBALDI

HTP0304
3 3/4" L X 2 3/8" DIA.
Shown in Antique Silver



MELROSE

HTP0274
4 3/4" L X 3 1/8" DIA.
Shown in Antique Silver



TAMA 40

HTP0294
4 1/4" L X 2 7/8" DIA.
Shown in Distressed Wood



TAPPO 40

HTP0264
1/2" L X 2 1/8" DIA.
Shown in Sienna

Available colors
Rods, supports & finials

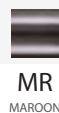
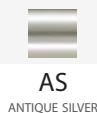

NEXGEN WOOD • 2" DIAMETER

i Wave Drape is available for Nexgen Wood. See page 3 for product codes and details. Nexgen Wood technical diagrams Page 21.

COLOR FOR RAIL AND SUPPORTS WILL BE CHOSEN BY THE FACTORY.
RAIL IS HIDDEN BEHIND THE DECORATIVE WOOD FACADE.



HAND DRAW

ENSEMBLE INCLUDES:
RODDING, NEXGEN GLIDES, FLING WAND.

*EXTRA FLING WAND FOR CENTER OPENING
DRAPES IS SOLD SEPARATELY.*

ONE WAY - CORDED

ENSEMBLE INCLUDES:
RODDING, NEXGEN GLIDES, PULLEY.

CENTER DRAW - CORDED

ENSEMBLE INCLUDES:
RODDING, NEXGEN GLIDES, PULLEY.

SUPPORT STYLE



FINIAL STYLES & COLORS

ANTIKA HTP0026



TAPPO 50 HTP0016



DW
DISTRESSED WOOD

GL
GOLD

AS
ANTIQUÉ SILVER

MH
MAHOGANY

SD
SANDAL

DW
DISTRESSED WOOD

GL
GOLD

AS
ANTIQUÉ SILVER

MH
MAHOGANY

SD
SANDAL

DHARMA HTP0036



TREVI HTP0046



DW
DISTRESSED WOOD

GL
GOLD

AS
ANTIQUÉ SILVER

MH
MAHOGANY

SD
SANDAL

DW
DISTRESSED WOOD

GL
GOLD

AS
ANTIQUÉ SILVER

MH
MAHOGANY

SD
SANDAL

Available colors
Wood rods

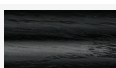

DW
DISTRESSED WOOD

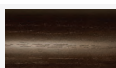

WE
WENGE

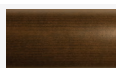

FG
FUDGE

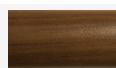

M
MOCHA

SHARED COMPONENTS • NEXGEN, TEKNO 40, NEXGEN WOOD

i Wave Drape is available for Nexgen, Tekno 40, Nexgen Wood. See page 18 for product codes and details.



HMP5010
CLIC GLIDE SYSTEM
Glides simply clic into rail



HMP5020
BALL BEARING CARRIER



HMP5012
NEXGEN GLIDE



HMP5340
TEKNO WHEELED CARRIER



HMP7020
END STOP CLIC
Adjustable end stop blocks glides at any position on rail



HMP7360 - 36"
HMP7480 - 48"
HMP7600 - 60"
HMP7720 - 72"
ALUMINIUM FLING WANDS
AVAILABLE COLORS:
BR, DA

i Rods longer than 106" will be shipped in two equal lengths. One piece can be requested. Extra shipping charges apply.

Rod length	36"	48"	60"	72"	84"	96"	106"	120"	132"	144"	156"	168"	180"
Nexgen Glides	12	16	20	24	28	32	36	40	44	48	52	56	60
Supports	2	2	2	3	3	3	4	5	5	5	5	5	5
Splice	0	0	0	0	0	0	0	1	1	1	1	1	1

i Technical diagrams for Euro-scope Upgrade page 21.

EURO-SCOPE UPGRADE



EURO-SCOPE UPGRADE

ENSEMBLE INCLUDES:
RODDING, CARRIERS AND ALL NECESSARY MOUNTING HARDWARE.
Euro-Scope rod hangs below front rod.
Make Euro-scope drape a minimum of 3/4" shorter than front drape.

AVAILABLE COLORS: BR, DA, F, W



STANDARD
INSTALLATION



EURO-SCOPE
UPGRADE



TEKNO 25 WITH
EURO-SCOPE UPGRADE

COMPATIBILITY

DRAPES WITH : NEXGEN GLIDES

Rod Dimensions	Hand Draw	One Way	Center	Tekno Carriers
48" - 72"	R	R	R	NR
84" - 96"	R	R	R	S
106"	R	R	R	S
120"	R	R	R	S
132"	L	L	R	S
144" - 156"	L	L	L	S
168" - 180"	NR	NR	L	S

DRAPES WITH : STANDARD WAVE CARRIER

Rod Dimensions	Hand Draw	One Way	Center	Tekno Carriers
48" - 72"	R	R	R	NR
84" - 96"	R	R	R	S
106"	R	R	R	S
120"	R	R	R	S
132"	L	L	R	S
144" - 156"	L	L	L	S
168" - 180"	NR	NR	NR	S

DRAPES WITH : STANDARD SNAP CARRIER

Rod Dimensions	Hand Draw	One Way	Center	Tekno Carriers
48" - 72"	R	R	R	NR
84" - 96"	R	R	R	S
106"	R	R	R	S
120"	L	L	R	S
132"	L	L	L	S
144" - 156"	L	L	L	S
168" - 180"	NA	NA	NA	S

RECOMMENDED LIGHTWEIGHT DRAPES ONLY SUGGESTED FOR HEAVY DRAPES NOT RECOMMENDED NOT AVAILABLE

TEKNO CARRIERS

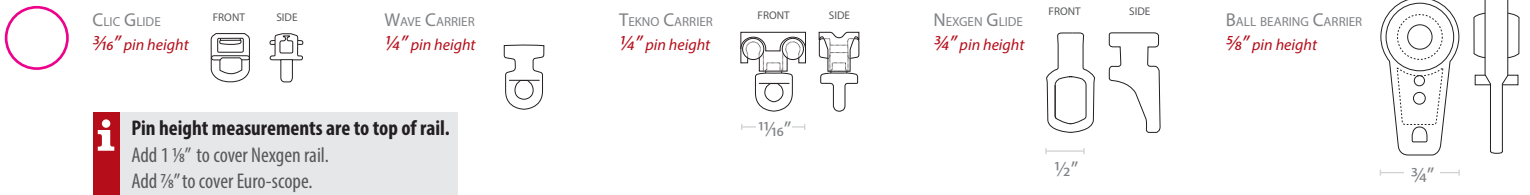

EURO-SCOPE

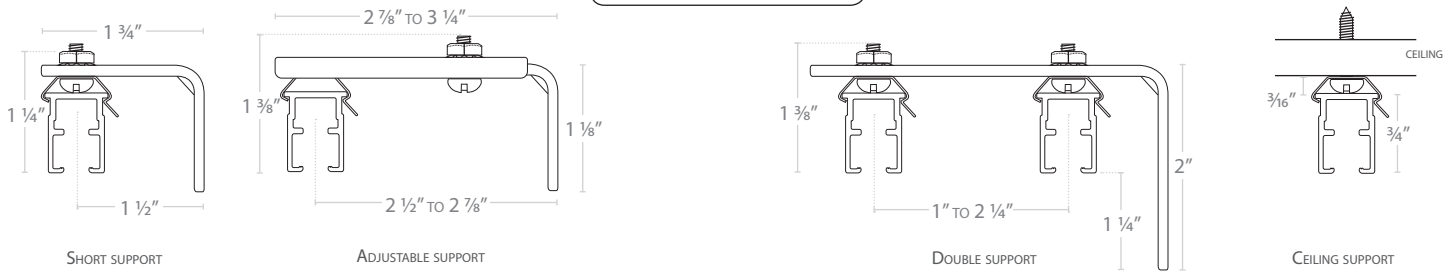

TEKNO 25

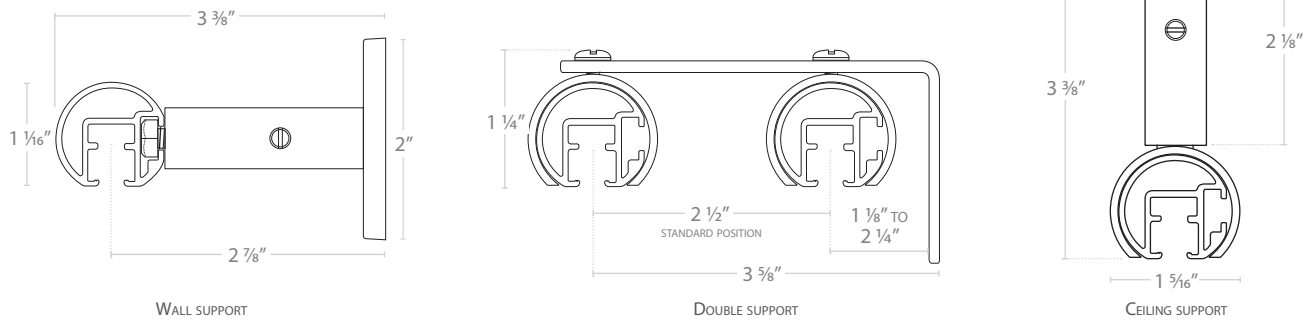

KONTUR ALU & EVO

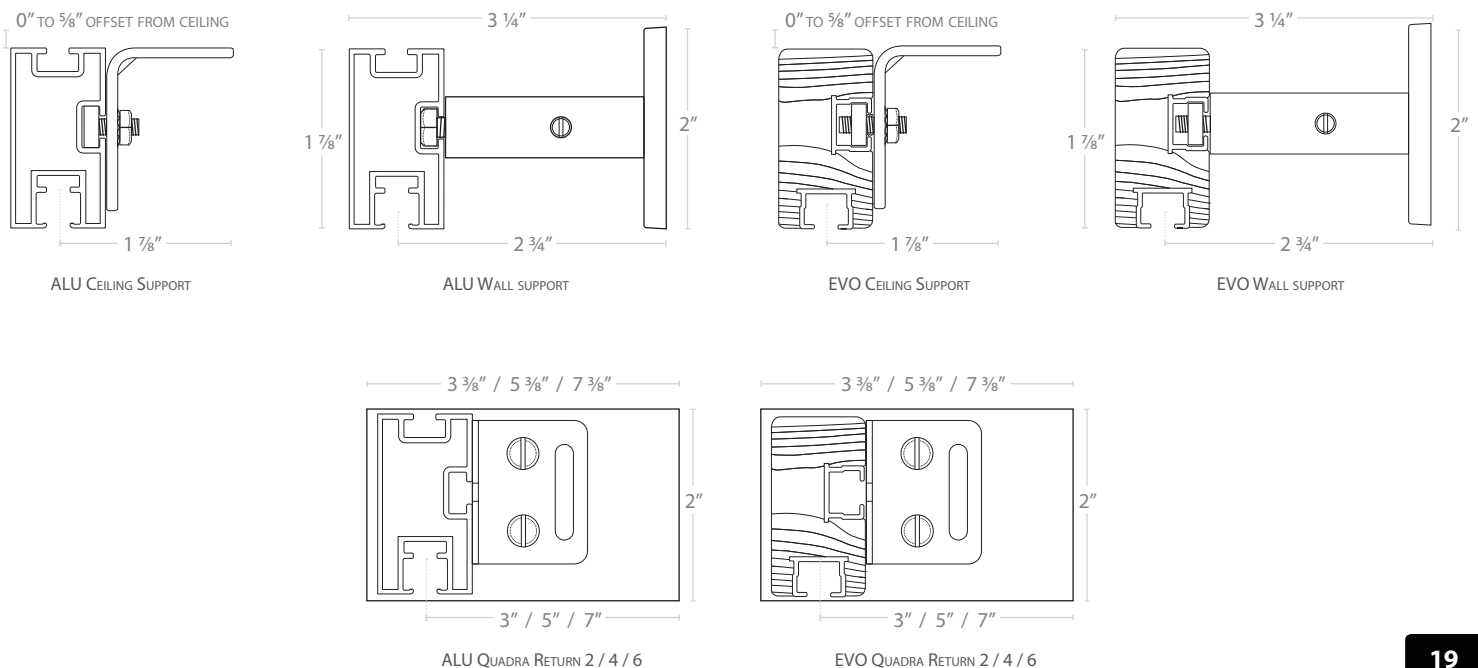

URBAN 3 & 5

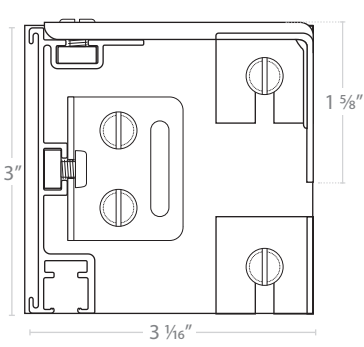

URBAN 3 RETURN 3
Showing all hardware

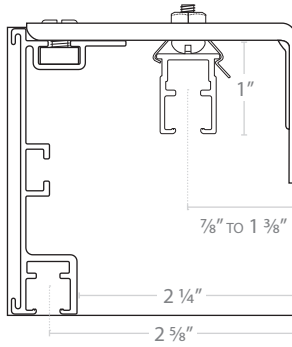

URBAN 3 RETURN 3
With Euro-Scope upgrade

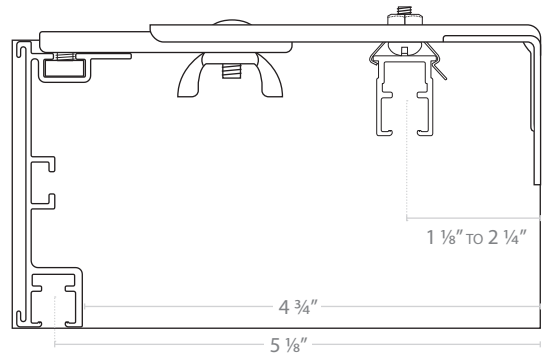

URBAN 3 - RETURN 5.5
With Euro-Scope upgrade

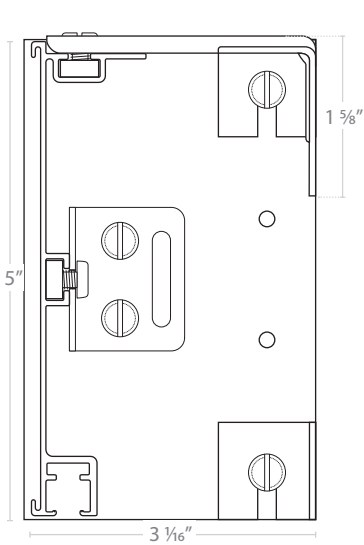

URBAN 5 RETURN 3
Showing all hardware

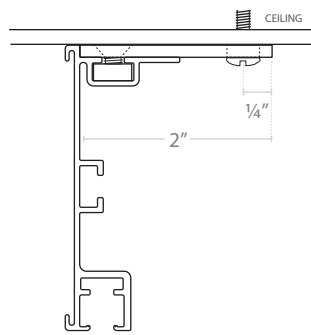

URBAN 3 CEILING SUPPORT

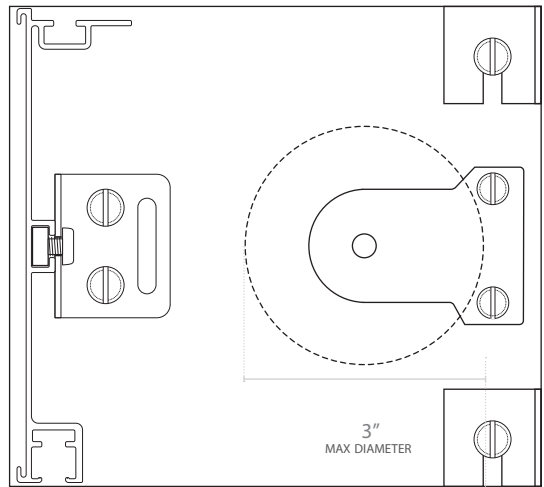

URBAN 5 - RETURN 5.5
Shade installation

INVISIBLE

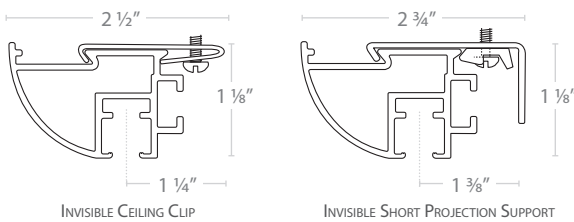

INVISIBLE CEILING CLIP

INVISIBLE SHORT PROJECTION SUPPORT

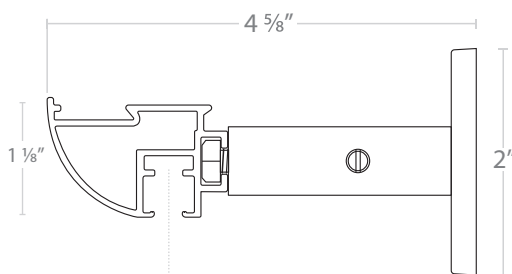

INVISIBLE TEKNO 2" PROJECTION
for Tekno 4" - add 2" for measurements from wall

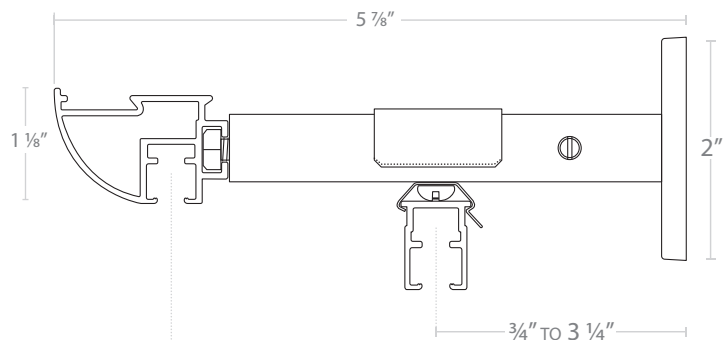

INVISIBLE TEKNO 4" PROJECTION WITH EURO SCOPE UPGRADE
for Tekno 6" projection - add 2" for measurements from wall

TECHNICAL INFORMATION • TEKNO PRODUCTS

NEXGEN

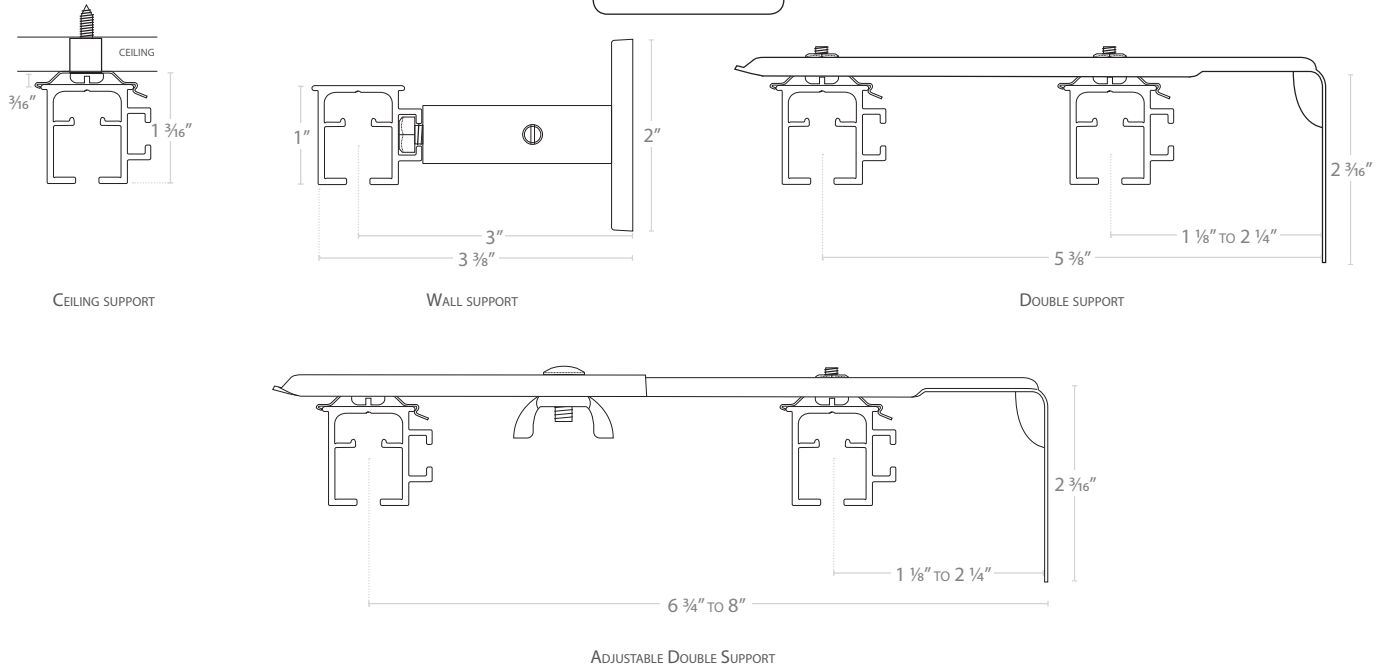

TEKNO 40

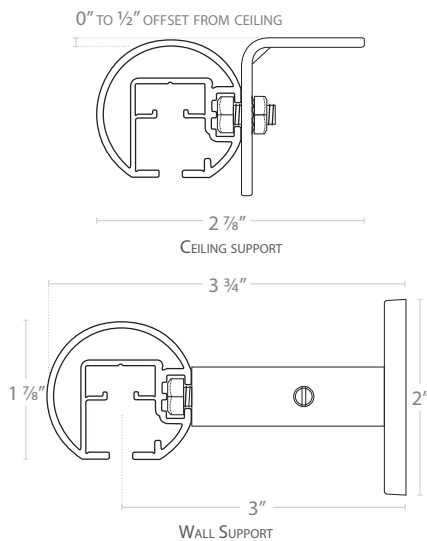

TEKNO 40 WOOD

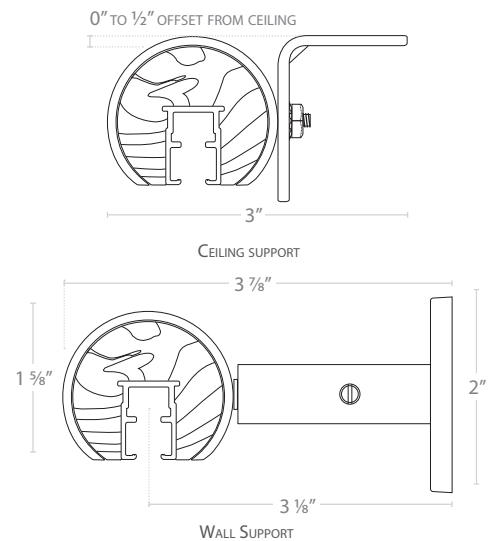

NEXGEN WOOD

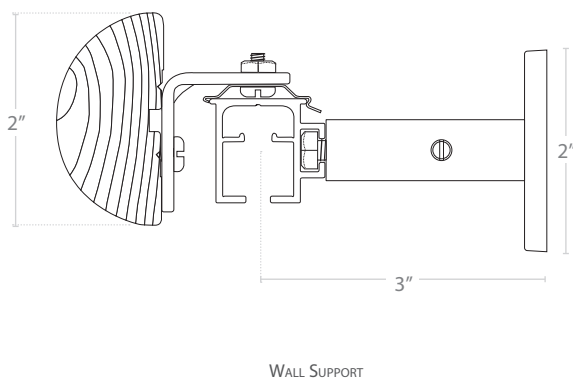

EURO-SCOPE UPGRADE

Offset between Euro-Scope Upgrade & front rod.

KONTUR EVO & ALU	7/16"
NEXGEN	1/2"
NEXGEN WOOD	1/2"
TEKNO 25	1/2"
TEKNO 40	3/4"
TEKNO 40 WOOD	1/2"
INVISIBLE	1/2"

i Make Back drapery a minimum of 3/4" shorter than front drapery.

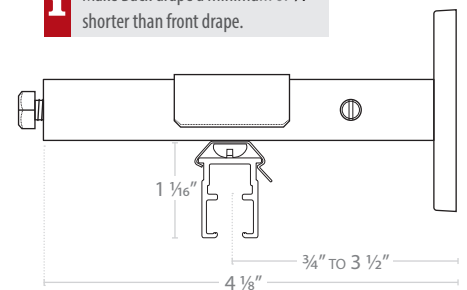

EURO-SCOPE INSTALLATION
 4" Support shown

SIMPLICITÉ • 1 1/8" DIAMETER



AERONAUT

HAP0658
3 1/2" L x 2" DIA.
Shown in Chrome - Black - Chrome
*Available colors:
CKC, CSC, SCS



CERAMIC BALL

HAP0688
3 3/8" L x 2 1/2" DIA.
Shown in Stainless
Available colors:
CR, S



CLARICE

HAP0718
3 1/4" x 2 DIA.
Shown in Antique Silver
Available colors:
A, AS, DW,



DELAUNY

HAP0728
3" x 2" DIA.
Shown in Antique
Available colors:
A, AS, DW



DIGITAL

HAP0598
3" L x 1 3/8" DIA.
Shown in Stainless
Available colors:
CR, DW, OB, S



DURAND

HAP0778
3" x 2 1/4" DIA.
Shown in Stainless
Available colors:
A, DW, S



EMPIRE

HFP0548
7/8" L x 1 5/8" DIA.
Shown in Chrome
Available colors:
CR, DW, OB, S



GEMSTONE

HAP0588
3 3/4" L x 2 1/8" DIA.
Shown in Distressed Wood
Available colors:
CR, DW, OB, S



JIBOO

HAP0758
3 1/4" x 2" DIA.
Shown in Antique
Available colors:
A, DW, S



JOFFRE

HAP0608
4" L x 2 1/8" DIA.
Shown in Antique Silver
Available colors:
AS, DW, OB



LALIQUE

HAP0678
2 1/8" L x 2" DIA.
Shown in Chrome
Available colors:
AS, DW, OB

ADDITIONAL COLORS



FB

FLAT BRONZE



GM

GUN METAL

Please see
www.dairedeco.com
in the Simplicité Box Set
section for options



LEPAPE

HAP0738
2 7/8" x 2 1/4" DIA.
Shown in Antique Silver
Available colors:
A, AS, DW



LINEA

HFP0568
4" L x 2 1/8" DIA.
Shown in Stainless
Available colors:
CR, DW, OB, S



MERCADO

HAP0668
2 5/8" L x 2 3/8" DIA.
Shown in Distressed Wood
Available colors:
AS, DW, OB



MUSKOKA

HAP0628
3 7/8" L x 2 3/8" DIA.
Shown in Oil Rubbed Bronze
Available colors:
AS, DW, OB



NOUVEAU CLASSIQUE

HAP0748
3 1/4" x 3" DIA.
Shown in Antique Silver
Available colors:
A, AS, DW



SILESTE

HAP0578
2 1/8" L x 2" DIA.
Shown in Chrome
Available colors:
CR, S



TAMA

HAP0638
3 3/8" L x 2 1/4" DIA.
Shown in Oil Rubbed Bronze
Available colors:
AS, DW, OB



TRANS LU

HFP0538
4" L x 2 1/8" DIA.
Shown in Stainless
Available colors:
CR, DW, OB, S



VENICE

HAP0708
3 1/2" L x 2 1/8" DIA.
Shown in Oil Rubbed Bronze
Available colors:
CR, DW, OB, S



VERSAILLES

HAP0698
2 1/8" L x 2 3/8" DIA.
Shown in Chrome
Available colors:
CR, DW, OB, S



Visit
www.dairedeco.com
to see the complete
assortment of different
finial and rod colors.

i Please see www.clairedeco.com
in the Simplicité Box Set section for options

COLOR & RODDING

i Set Length - Factory will NOT cut rodding

AVAILABLE COLORS



A
ANTIQUE



CR
CHROME



DW
DISTRESSED WOOD (BLACK)



OB
OIL RUBBED BRONZE



S
STAINLESS

COLOR FOR CERTAIN FINIALS ONLY



AS
ANTIQUÉ SILVER

PAIRS WITH STAINLESS ROD



FB
FLAT BRONZE



GM
GUN METAL

*AERONAUT COLOR CODES

CKC - CHROME, BLACK, CHROME
CSC - CHROME, STAINLESS, CHROME
SCS - STAINLESS, CHROME, STAINLESS

ROD LENGTHS

HATS3488 - 48"
HATS3608 - 60"
HATS3728 - 72"
HATS3968 - 96"

SUPPORTS



HFP6128
STAHL SUPPORT 2"



HFP6148
STAHL SUPPORT 4"

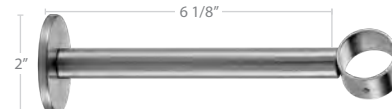

HFP6178
STAHL SUPPORT 6"



HAM6008
COMBO SUPPORT SELECT 28



TEKNO DOUBLE SUPPORT
HTP6228 - 4" SUPPORT
HTP6238 - 6" SUPPORT



HFP6168
LATERAL SUPPORT 28
Inside mount - deduct 1/4" from rod per bracket.
Maximum length of rod is 72"



OPTIONAL PRODUCTS



HAA5255
RING WITH EYELET
1 1/4"
Bag of 10



HFP5458
METRO RING
Eyelet included



HMP7360 - 36"
HMP7480 - 48"
HMP7600 - 60"
HMP7720 - 72"
ALUMINIUM FLING WANDS

AVAILABLE COLORS: BR, DA



HFP4468
UNI-ARM 28

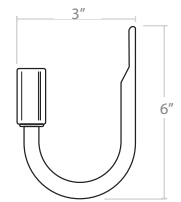

CORNER PROGRAM



HFP7018
CORNER 28
From 90° - 180°



Special kits available online at:
www.clairedeco.com

AVAILABLE COLORS



A
ANTIQUÉ



CR
CHROME



DW
DISTRESSED WOOD
(BLACK)



OB
OIL RUBBED BRONZE



S
STAINLESS

ADJUSTABLE ROD KITS • 5/8" - 1/2" DIAMETER



ADRIA
HAA1609
3 7/8" L X 2" DIA.
Shown in Onyx



ANTELOPE
HAA1626
4 1/2" L X 2 1/2" DIA.
Shown in Antique



BALL
HAA1616
1 1/2" L X 1" DIA.
Shown in Stainless



CODA
HAA1628
5 1/8" L X 2" DIA.
Shown in Antique



LARGE BALL
HAA1606
2 3/4" L X 2" DIA.
Shown in Antique



RENAISSANCE
HAA1621
4 7/8" L X 2 1/2" DIA.
Shown in Stainless



TORCH
HAA1614
5 1/2" L X 2" DIA.
Shown in Antique

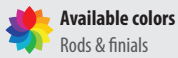

Available colors
Rods & finials



A
ANTIQUE



K
ONYX



S
STAINLESS

i **Ensembles include:**
Adjustable rod, finials & regular Combo Supports

KITS

Doublette ensembles include:
Back bracket & adjustable back rod.

	ADRIA	ANTELOPE	BALL	CODA	LARGE BALL	RENAISSANCE	TORCH	DOUBLETTE	ROD KITS
Pair of finials	HAA1609	HAA1626	HAA1616	HAA1628	HAA1606	HAA1621	HAA1614	-	-
28" - 48"	HAA2409	HAA2267	HAA2416	HAA2287	HAA2406	HAA2421	HAA2414	HAA2400	HAA1624
48" - 84"	HAA8409	HAA8267	HAA8416	HAA8287	HAA8406	HAA8421	HAA8414	HAA8400	HAA1684
66" - 120"	HAA6609	HAA6267	HAA6616	HAA6287	HAA6606	HAA6621	HAA6614	HAA6600	HAA1666
Tieback ensemble	HAA4509	HAA4267	HAA4516	HAA4287	HAA4506	HAA4521	HAA4514	-	-

SWING ARM

LENGTHS	ADRIA	ANTELOPE	BALL	CODA	LARGE BALL	RENAISSANCE	TORCH	NO FINIAL
14" - 22"	HAA5509	HAA5526	HAA5516	HAA5528	HAA5506	HAA5521	HAA5514	HAA5500
28" - 36"	HAA5609	HAA5626	HAA5616	HAA5628	HAA5606	HAA5621	HAA5614	HAA5600



SAN FRANCISCO PROGRAM

i **Ensembles include:**
(1) adjustable wall rod, (2) adjustable wing rods,
(2) San Francisco Corners, (4) supports
(Finials Sold separately)

CODE	WALL ROD	WING RODS
HAA2818	28" - 48"	18" - 32"
HAA2828	28" - 48"	28" - 48"
HAA4818	48" - 84"	18" - 32"
HAA4828	48" - 84"	28" - 48"
HAP7707	SAN FRANCISCO CORNER 5/8" DIAMETER	



CURVED ROD



LENGTHS	28" - 48"	48" - 84"	66" - 120"
CODE	HAA7024	HAA7048	HAA7084

OPTIONAL PRODUCTS & SUPPORTS



HAM1647
DOUBLE COMBO SUPPORT
Adj. projection - wall to pole
Front rod - 3 1/2" to 5 1/4"
Back rod - 1/4" to 2 9/8"



HAM1600
COMBO SUPPORT
3 1/2" to 5 1/4" Adj. projection,
wall to pole



HAM1641
SHORT COMBO SUPPORT
1 7/8" to 2 3/8" Adj. projection,
wall to pole



HAM1643
LATERAL SUPPORT [PAIR]



HAA1625
RING WITH EYELET
Bag of 10
1" DIAMETER



HAA1635
RING WITH PINCH CLIP
Bag of 10
1" DIAMETER



HAA1645
TIEBACK [PAIR]
Finials not included
3" height, 6" width

ADJUSTABLE ROD KITS • 1" - 7/8" DIAMETER



CLARICE

HAP0718
3 1/4" L x 2" DIA.
Shown in Antique Silver
Available colors: AS, DW



DELAUNEY

HAP0728
3" L x 2 1/4" DIA.
Shown in Antique Silver
Available colors: AS, DW, OB



IONIC

HAP0375
3" L x 2 1/2" DIA.
Shown in Distressed Wood
Available colors: AS, DW, OB



LALIQUE

HAP0678
1 3/4" L x 3" DIA.
Shown in Distressed Wood
Available colors: AS, DW, OB



LEPAPE

HAP0738
2 7/8" L x 2 1/4" DIA.
Shown in Distressed Wood
Available colors: AS, DW



MERCADO

HAP0668
2 3/8" L x 2 3/8" DIA.
Shown in Distressed Wood
Available colors: AS, DW, OB



MUSKOKA

HAP0628
3 7/8" L x 2 5/8" DIA.
Shown in Antique Silver
Available colors: AS, DW, OB



NOUVEAU CLASSIQUE

HAP0748
3 1/8" L x 3" DIA.
Shown in Antique Silver
Available colors: AS, DW



TAMA

HAP0638
3 5/8" L x 2 1/4" DIA.
Shown in Oil Rubbed Bronze
Available colors: AS, DW, OB



Visit www.clairedeco.com to see the complete assortment of different finial and rod colors.

AVAILABLE COLORS



AS
ANTIQUE SILVER



DW
BLACK



OB
OIL RUBBED BRONZE

ADJUSTABLE ROD KITS

FINIALS	CLARICE	DELAUNEY	IONIC 25	LALIQUE	LE PAPE	MERCADO	MUSKOKA	N. CLASSIQUE	TAMA	DOUBLETTE
28" - 48"	HAA2715	HAA2725	HAA2375	HAA2675	HAA2735	HAA2665	HAA2625	HAA2745	HAA2635	HAA2002
48" - 84"	HAA8715	HAA8725	HAA8375	HAA8675	HAA8735	HAA8665	HAA8625	HAA8745	HAA8635	HAA8002
60" - 108"	HAA6715	HAA6725	HAA6375	HAA6675	HAA6735	HAA6665	HAA6625	HAA6745	HAA6635	HAA6002

• ENSEMBLES INCLUDE: ADJUSTABLE ROD, FINIALS AND REGULAR COMBO SUPPORTS. • DOUBLETTE ENSEMBLES INCLUDE: BACK BRACKET AND ADJUSTABLE BACK ROD.

OPTIONAL SUPPORTS



HAM6005

COMBO SUPPORT SELECT 25
Supports are included in ensembles,
use for replacement parts only

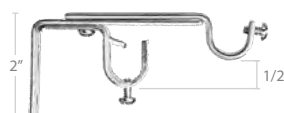

HFP6475

DOUBLE COMBO SUPPORT 25
Adjustable projection from wall to pole
Front rod - 3" to 4 1/8"
Back rod - 1/4" to 2 5/8"

OPTIONAL PRODUCTS



HMP7360 - 36"
HMP7480 - 48"
HMP7600 - 60"
HMP7720 - 72"
ALUMINIUM FLING WANDS

AVAILABLE COLORS: BR, DA



HAA5355
RING WITH CLIP
Bag of 10



HAA5255
RING WITH EYELET
Bag of 10

WROUGHT IRON • 3/4" DIAMETER



BALLFORT HFP0032 2 7/8" L x 2" D <i>Shown in Antique</i>	BELLAGIO HFP0432 5 1/2" L x 3" D <i>Shown in Pewter</i>	BISTROT HFP0372 5 1/2" L x 3 1/4" D <i>Shown in Antique</i>	CAPUCHON 18 HFP0182 1" L x 1 3/8" D <i>Shown in Fossil</i>	DANTE HFP0412 5 1/2" L x 4 1/2" D <i>Shown in Military Black</i>	DARDUS HFP0122 7 1/4" L x 2 1/4" D <i>Shown in Pewter</i>	MAGNUM HFP0382 2 1/2" L x 1 3/4" D <i>Shown in Pewter</i>	VECTRA HFP0232 1 7/8" L x 1 3/4" D <i>Shown in Antique</i>
--	---	---	--	--	---	---	--

AVAILABLE COLORS

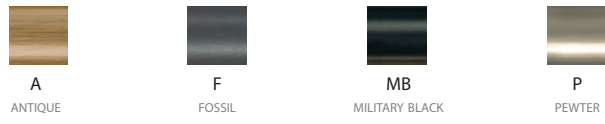

RODDING



HFTS3002 - STEEL TUBE

- ALL MEASUREMENTS MUST BE FOR ROD LENGTH ONLY.
- MAXIMUM LENGTH FOR A SINGLE ROD IS 96".
- AFTER 84" A CENTER SUPPORT IS REQUIRED.
- RODS GREATER THAN 96" WILL BE SHIPPED IN 2 EQUAL PIECES.

SUPPORTS

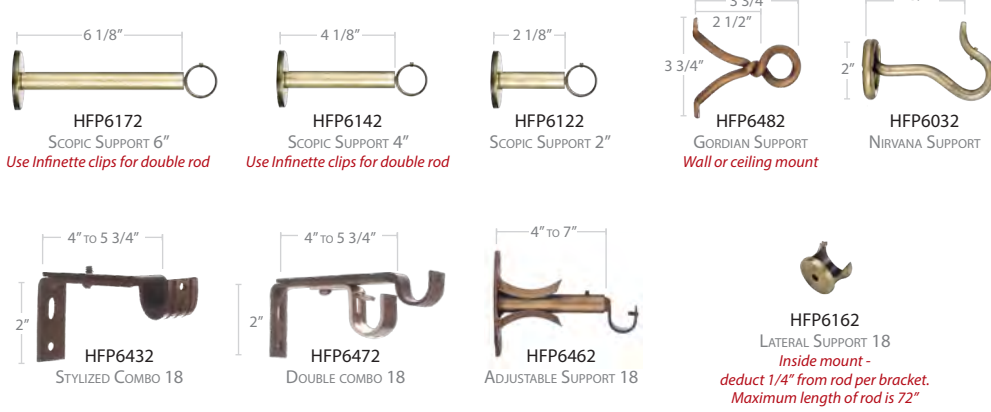

OPTIONAL PRODUCTS

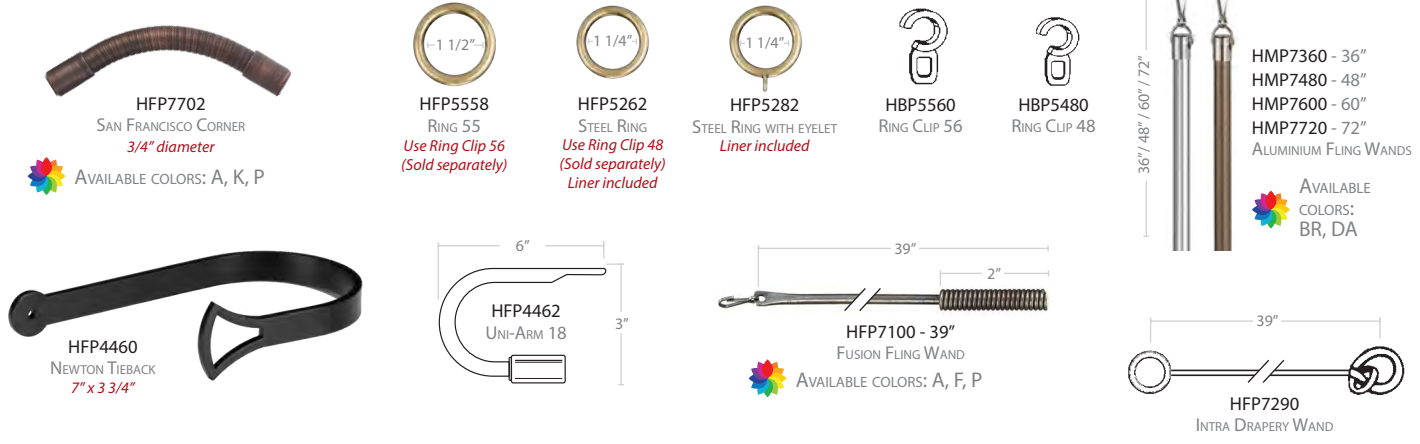

INFINETTE CLIPS



WROUGHT IRON • 1" DIAMETER



BALL 25

HAP0295
3 3/4" L x 2 1/4" D
Shown in Antique



CAPUCHON 25

HFP0185
1" L x 1 3/8" D
Shown in Fossil



FABRIXX

HFP0485
3 3/4" L x 2 1/4" D
Shown in Antique



FLAMME 25

HFP0255
4 1/4" L x 3" D
Shown in Military Black



GRAPPA

HAP0335
3 3/4" L x 2 1/4" D
Shown in Antique



PIPER

HFP0235
1 7/8" L x 1 3/4" D
Shown in Pewter



TRINITY

HFP0385
2 1/2" L x 1 3/4" D
Shown in Antique

AVAILABLE COLORS



A
ANTIQUE



F
FOSSIL



MB
MILITARY BLACK



P
PEWTER

RODDING



HFTS3005
STEEL TUBE

HFTS3002
STEEL TUBE

Use 3/4" ONLY FOR BACK RODS WITH INFINETTE CLIPS OR DOUBLE COMBO 25

- ALL MEASUREMENTS MUST BE FOR ROD LENGTH ONLY.
- MAXIMUM LENGTH FOR A SINGLE ROD IS 96".
- AFTER 84" A CENTER SUPPORT IS REQUIRED.
- RODS GREATER THAN 96" WILL BE SHIPPED IN 2 EQUAL PIECES.

SUPPORTS



HFP6175

ELYPTIC SUPPORT 6"
Use Infinette clips for double rod



HFP6145

ELYPTIC SUPPORT 4"
Use Infinette clips for double rod

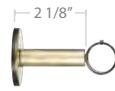

HFP6125

ELYPTIC SUPPORT 2"



HFP6165
LATERAL SUPPORT 25

Inside mount - deduct 1/4" from rod per bracket.
Maximum length of rod is 72"



HFP6435

STYLISTED COMBO 25



HFP6475

DOUBLE COMBO 25



HFP6485

AVALON SUPPORT
Wall or ceiling mount



HFP6035

GINSA SUPPORT

OPTIONAL PRODUCTS



HFP5558

RING 55
Use Ring Clip 56 (Sold separately)



HFP5262

STEEL RING
Use Ring Clip 48 (Sold separately)
Liner included



HFP5282

STEEL RING WITH EYELET
Liner included

36" / 48" / 60" / 72"



HMP7360 - 36"
HMP7480 - 48"
HMP7600 - 60"
HMP7720 - 72"
ALUMINIUM FLING WANDS

AVAILABLE COLORS:
BR, DA

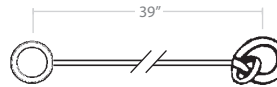

HFP7290

INTRA DRAPERY WAND



HFP7100 - 39"

FUSION FLING WAND

AVAILABLE COLORS: A, F, P



HBP5560
RING CLIP 56



HBP5480
RING CLIP 48



HFP4465

UNI-ARM 25



HFP4460
NEWTON TIEBACK
7" x 3 3/4"

INFINETTE CLIPS



HFP6712

REGULAR CLIP 3/4"
Attaches 3/4" diameter rods to Elyptic Supports



HFP6722

BUTTERFLY CLIP 3/4"
Bridges 3/4" diameter rods to Elyptic Supports



HFP6732

ALTERNATE CLIP
Attaches an alternate rod to a Elyptic Support



HFP6742

ALTERNATE BUTTERFLY CLIP
Attaches an alternate rod to a Elyptic Support

METRO • 1 1/8" DIAMETER



BALL 28
HFP0048
3 3/8" L x 2 3/8" D
SHOWN IN BURNT NICKLE



BLING
HFP0498
2 1/4" L x 2" D
SHOWN IN SAHARA



EMPIRE
HFP0548
7/8" L x 1 3/8" D
SHOWN IN VINTAGE BRASS



LINEA
HFP0568
4" L x 2" D
SHOWN IN STAINLESS



SQUARE ENDCAP
HFP0508
2" x 3/4"
SHOWN IN SAHARA

AVAILABLE COLORS



A
ANTIQUÉ



BN
BURNT NICKLE



S
STAINLESS



SH
SAHARA



VB
VINTAGE BRASS



Visit www.clairedeco.com
to see the complete assortment
of different finish and rod colors.

RODDING



HFTS3008
STEEL TUBE



- ALL MEASUREMENTS MUST BE FOR ROD LENGTH ONLY.
- MAXIMUM LENGTH FOR A SINGLE ROD IS 96".
- AFTER 84" A CENTER SUPPORT IS REQUIRED.
- RODS GREATER THAN 96" WILL BE SHIPPED IN 2 EQUAL PIECES.



C-Rings and C-Ring Supports make
sliding your drapes along the rod a breeze.



SUPPORTS

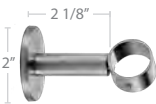

HFP6128
STAHL SUPPORT 2"



HFP6148
STAHL SUPPORT 4"



HFP6178
STAHL SUPPORT 6"



HFP6168
LATERAL SUPPORT 28
*inside mount -
deduct 1/4" from rod per bracket.
Maximum length of rod is 72"*

OPTIONAL PRODUCTS



HFP5458
METRO RING
Eyelet included



HFP4468
UNI-ARM 28

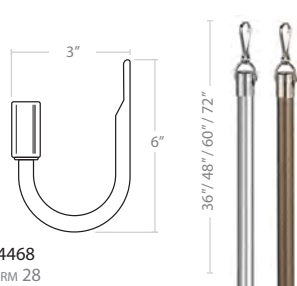

HMP7360 - 36"
HMP7480 - 48"
HMP7600 - 60"
HMP7720 - 72"
ALUMINIUM FLING WANDS

AVAILABLE
COLORS:
BR, DA



HFP5408
PASS THRU RING

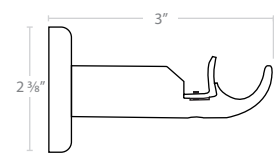

HFP6038
PASS THRU SUPPORT

EURO-SCOPE DOUBLE ROD UPGRADE



Ensembles include: rodding, clic glides,
and all necessary mounting hardware.



AVAILABLE COLORS: BR, DA, F, W

SIZE UP TO	36"	48"	60"	72"	84"	96"	*108"	*120"	*132"	*144"	*156"
SPLICE	0	0	0	0	0	0	1	1	1	1	1
HAND DRAWN	HEH4030	HEH4040	HEH4050	HEH4060	HEH4070	HEH4080	HEH4090	HEH4100	HEH4110	HEH4120	HEH4130
ONE WAY	HEO4030	HEO4040	HEO4050	HEO4060	HEO4070	HEO4080	HEO4090	HEO4100	HEO4110	HEO4120	HEO4130
CENTER DRAW	HEC4030	HEC4040	HEC4050	HEC4060	HEC4070	HEC4080	HEC4090	HEC4100	HEC4110	HEC4120	HEC4130

* RODS LONGER THAN 106" WILL BE SHIPPED IN TWO EQUAL PIECES TO AVOID HIGH TRANSPORT COSTS, BUT CAN BE ORDERED IN ONE PIECE WITH EXTRA SHIPPING AND HANDLING CHARGES.

PLEASE SPECIFY IF ONE PIECE IS REQUESTED.

i Available colors for **finials** are identified in **RED TEXT**.

WROUGHT IRON • 1 1/2" DIAMETER



ACCENT

HFP0024
3 5/8" L x 2 1/2" D
Shown in Antique
A, F, P

ARON

HTP0204
4" L x 2 3/4" D
Shown in Distressed Wood
AS, DW

ELFIN

HTP0284
4" L x 2 3/4" D
Shown in Antique Silver
AS, DW

GARIBALDI

HTP0304
3 3/4" L x 2 5/8" D
Shown in Pewter
A, F, P

MELROSE

HTP0274
4 3/4" L x 3 1/8" D
Shown in Antique Silver
AS, DW

SINGULAR

HFP0074
6" L x 2 3/8" D
Shown in Pewter
A, F, P

TAMA 40

HTP0294
4 1/4" L x 2 7/8" D
Shown in Distressed Wood
AS, DW

TAP

HFP0014
1 1/2" L x 1 5/8" D
Shown in Antique
A, F, P

AVAILABLE COLORS



A
ANTIQUE



F
FOSSIL



P
PEWTER

COLOR FOR CERTAIN FINIALS ONLY



AS
ANTIQUE SILVER

PAIRS WITH PEWTER ROD



DW
DISTRESSED WOOD

RODDING



HFTS3004
STEEL TUBE

- ALL MEASUREMENTS MUST BE FOR ROD LENGTH ONLY.
- MAXIMUM LENGTH FOR A SINGLE ROD IS 96".
- AFTER 84" A CENTER SUPPORT IS REQUIRED.
- RODS GREATER THAN 96" WILL BE SHIPPED IN 2 EQUAL PIECES.

SUPPORTS

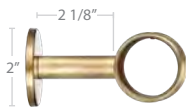

HFP6124
VERSA 40 SUPPORT - 2"
Wall or ceiling mount



HFP6144
VERSA 40 SUPPORT - 4"
Wall or ceiling mount



HFP6174
VERSA 40 SUPPORT - 6"
Wall or ceiling mount



HFP6104
RUSTICA SUPPORT



HFP6114
ADJUSTABLE SUPPORT 40



HFP6164
LATERAL SUPPORT 40
Inside mount - deduct 1/4" from rod per bracket.
Maximum length of rod is 72"



OPTIONAL PRODUCTS



HMP7360 - 36"
HMP7480 - 48"
HMP7600 - 60"
HMP7720 - 72"
ALUMINIUM FLING WANDS

AVAILABLE COLORS:
BR, DA



HFP7100 - 39"
FUSION FLING WAND

AVAILABLE COLORS:
A, F, P



HFP5824
RING 82
Use Ring Clip 83 (sold separately)



HFP5604
STEEL RING 40
With Eyelet
Liner included



HBP5830
RING CLIP 83



HFP4400
PASSAMA TIEBACK



HFP4410
RUSTICA BALL TIEBACK



HFP4020
GANCHO HOCK

INFINETTE INSTALLATIONS



BUTTON

HBP0300
Ø 7/8"



CORD

HFP0820
Ø 2 1/2"



STAR

HFP0740
Ø 2 7/8"



FANETTE

HFP0720
Ø 2 3/4"



FORBIN

HFP0600
Ø 3"



GRAPPA

HFP0620
Ø 3 1/2"



HORIZON

HFP0860
Ø 2 3/4"



LILLIANE

HFP0630
Ø 3 1/2"



LOUIS XVI

HBP0390
Ø 2 5/8"



LOUIS XV

HBP0310
Ø 2 3/4"



MANHATTAN

HFP0610
Ø 3"



PETALINE

HFP0640
Ø 3 1/2"

AVAILABLE COLORS



A
ANTIQUÉ



F
FOSSIL



P
PEWTER

RODDING

HFTS3007
STEEL TUBE - Ø 5/8"



Over 72" requires a center support

HFTS3002
STEEL TUBE - Ø 3/4"



Over 84" requires a center support

HIA1328



ADJUSTABLE ROD KIT 28" to 48"
Infinette Clips are included

HIA1348 48" to 84"
HIA1366 66" to 120"



ADJUSTABLE ROD KIT
Center support and
Infinette Clips are included

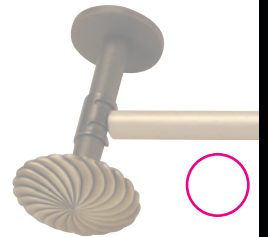

SUPPORTS



2" or 4"
HFP4027 - 2"
HFP4047 - 4"
EXTENDER FOR POST COMPLETE

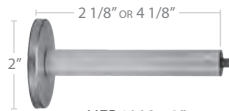

2 1/8" or 4 1/8"
2"
HFP4002 - 2"
HFP4004 - 4"
POST COMPLETE

SMALL: 1 7/8" to 2 3/8"
MEDIUM: 3 1/2" to 5 1/4"
LARGE: 6 1/4" to 7 1/2"



HFP6107 - 5/8" HFP6307 - 5/8" HFP6707 - 5/8"
HFP6102 - 3/4" HFP6302 - 3/4" HFP6702 - 3/4"
SUPPORT SMALL SUPPORT MEDIUM SUPPORT LARGE

Use as a center support
instead of a medallion
with post.



HFP6117 - 5/8"
HFP6112 - 3/4"
CRADLE
Cradle used as a rod support
with Post Complete



HFP6137 - 5/8"
HFP6132 - 3/4"
CLOSED CRADLE
Closed Cradle is used as a rod support with Post Complete.
Ideal for ceiling installations.



HFP6127 - 2"
HFP6147 - 4"
360° BRACKET WITH POST
Use for lateral, ceiling or angled installations

OPTIONAL PRODUCTS



HAP7707 - 5/8"
HFP7702 - 3/4"
SAN FRANCISCO CORNER



HFP5207
RING EURO 20
Use Ring Clip 48



HFP5347
RING EURO 34
Use Ring Clip 48



HFP5262
STEEL RING
Use Ring Clip 48
(Liner included)



HFP5282
STEEL RING WITH EYELET
Liner included



HFP7017 - 5/8"
HFP7012 - 3/4"
NYLON PLUG



HAA1635
RING WITH CLIP
Bag of 10



HBP5480
RING CLIP 48



HAA1625
RING WITH EYELET
Bag of 10

INFINETTE CLIPS



HFP6713 - 1/2"
HFP6717 - 5/8"
HFP6712 - 3/4"
REGULAR CLIP
Attaches rods to a Post Complete



HFP6723 - 1/2"
HFP6727 - 5/8"
HFP6722 - 3/4"
BRIDGE CLIP
Bridges rods to a Post Complete



HFP6732
ALTERNATE CLIP
Attaches an alternate rod
to a Post Complete



HFP6742
ALTERNATE BUTTERFLY CLIP
Attaches an alternate rod
to a Post Complete

BRASS COLLECTION • 1" DIAMETER



ENDCAP 25

HBP0115
1" L x 1 1/8" D
Shown in Brass
Available colors: B, N



REGENT

HBP0015
1 7/8" L x 1 1/16" D
Shown in Nickel
Available colors: B, N



BRAVA

HBP0215
2" L x 3" D
Shown in Brass
Available colors: B, N



FUEGO

HBP0105
4 1/2" L x 2" D
Shown in Brass
Available colors: B, N

CREATE YOUR FINIALS WITH PIECES IN BRASS, NICKEL OR ONYX!



KOSMO

HBA0415
1 7/8" L x 1 1/16" D
Combination shown:
Brass, Onyx, Brass (BKB)

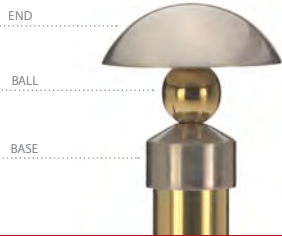

URBAN

HBA0445
3" L x 1 5/8" D
Combination shown:
Nickel, Brass, Nickel (NBN)

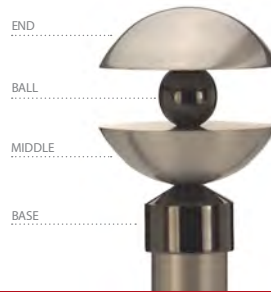

MASONIC

HBA0505
2" L x 3" D
Combination shown:
Nickel, Onyx, Nickel, Onyx (NKNK)

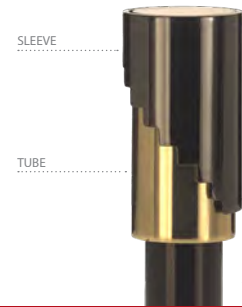

ESCALA

HBA0405
3" L x 1 5/8" D
Combination shown:
Onyx, Brass (KB)

AVAILABLE COLORS FOR BRASS PRODUCTS

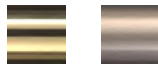

B BRASS
N NICKEL

AVAILABLE COLORS FOR WOOD RODS



CM CHERRY
WN WALNUT

RODDING



HBT3005 - BRASS TUBE



HBTW3005 - WOOD POLE

- ALL MEASUREMENTS MUST BE FOR ROD LENGTH ONLY.
- MAXIMUM LENGTH FOR A SINGLE ROD IS 96".
- AFTER 84" A CENTER SUPPORT IS REQUIRED.
- RODS GREATER THAN 96" WILL BE SHIPPED IN 2 EQUAL PIECES.

SUPPORTS

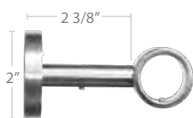

HBP6205 — SUPPORT 2"
HBP6225 — CENTER SUPPORT 2"



HBP6405 — SUPPORT 4 3/4"
HBP6425 — CENTER SUPPORT 4 3/4"

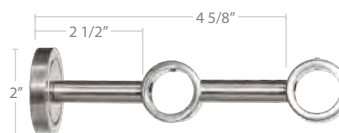

HBP6505
DOUBLE SUPPORT



HBP6605
STUDIO
CABLE RING
Inside mount -
deduct 3/16" from rod per bracket.
Maximum length of rod is 72"

AVAILABLE COLORS: B, N

OPTIONAL PRODUCTS



HBP5558
RING 55
Use Ring Clip 56
(sold separately)



HBP5560
RING CLIP 56



HBP5478
CABLE RING
Use Ring Clip 48
(sold separately)



HBP5480
RING CLIP 48

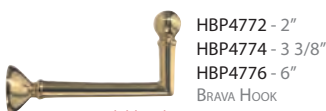

HBP4772 - 2"
HBP4774 - 3 3/8"
HBP4776 - 6"
BRAVA HOOK
Available colors: B, N



HBP4782 - 2"
HBP4786 - 6"
LIBERTI HOOK
Available color: A



HBP4792 - 2"
HBP4794 - 4"
HBP4796 - 6 3/4"
LOUIS HOOK
Available color: A

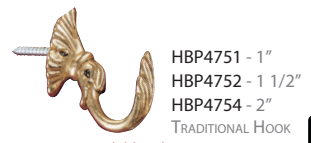

HBP4751 - 1"
HBP4752 - 1 1/2"
HBP4754 - 2"
TRADITIONAL HOOK
Available color: A

BRASS COLLECTION • 1 1/8" DIAMETER



ENDCAP 28

HBP0208
1" L x 1 1/4" D
Shown in Brass
Available colors: B, N



BALBINA

HBP0138
3 1/4" L x 2 3/8" D
Shown in Brass
Available colors: B, N



CHALICE

HBP0238
2 1/2" L x 2 1/4" D
Shown in Nickel
Available colors: B, N



CALIENTE

HBP0108
4 1/8" L x 2" D
Shown in Brass
Available colors: B, N



SHIITAKE

HBP0098
2" L x 2 1/8" D
Shown in Nickel
Available colors: B, N



SYLO

HBP0268
2 1/4" L x 2 1/4" D
Shown in Nickel
Available colors: B, N



CORONA

HBP0058
4 1/2" L x 2 1/2" D
Shown in Brass
Available colors: A, B



LIBERTI

HBP0158
4 1/2" L x 2 3/4" D
Shown in Brass
Available colors: B



LOUIS XVI

HBP0048
3 3/4" L x 2 5/6" D
Shown in Antique
Available colors: A, B



RODOPLISSÉ

HBP0068
3 1/8" L x 2 1/4" D
Shown in Brass
Available colors: B



SHERATON

HBP0168
4 1/2" L x 2 1/2" D
Shown in Brass
Available colors: B



TORSADE

HBP0188
2 3/4" L x 2 3/4" D
Shown in Brass
Available colors: B

AVAILABLE COLORS FOR BRASS PRODUCTS



B
BRASS
N
NICKEL

AVAILABLE COLORS FOR WOOD RODS



CM
CHERRY
WN
WALNUT

RODDING



HBT3008 - BRASS TUBE



HBTW3008 - WOOD POLE

- ALL MEASUREMENTS MUST BE FOR ROD LENGTH ONLY.
- MAXIMUM LENGTH FOR A SINGLE ROD IS 96".
- AFTER 84" A CENTER SUPPORT IS REQUIRED.
- RODS GREATER THAN 96" WILL BE SHIPPED IN 2 EQUAL PIECES.

SUPPORTS

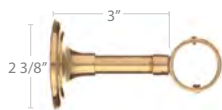

HBP6308 — SUPPORT 3"
HBP6328 — CENTER SUPPORT 3"



HBP6508 — SUPPORT 4 7/8"
HBP6528 — CENTER SUPPORT 4 7/8"



HBP6808 — SUPPORT 7 1/4"
HBP6818 — CENTER SUPPORT 7 1/4"



HBP6608
STUDIO 1 1/8"
Inside mount - deduct 3/16" from rod per bracket.
Maximum length of rod is 72"

OPTIONAL PRODUCTS



HBP5558
RING 55
Use Ring Clip 56 (sold separately)



HBP5560
RING CLIP 56



HBP5478
CABLE RING
Use Ring Clip 48 (sold separately)



HBP5480
RING CLIP 48



Available colors: B, N



Available color: A



Available color: A



Available color: A

BRASS COLLECTION • 1 1/2" DIAMETER



BARTOLI

HBP0134

3 3/8" L x 2 1/2" D

Shown in Brass

Available colors: B, N



CALIX

HBP0144

3" L x 2 1/4" D

Shown in Nickel

Available colors: B, N



CORONET

HBP0174

3 1/8" L x 2 1/4" D

Shown in Brass

Available colors: B



FACETTE

HBP0074

4 1/2" L x 2 1/2" D

Shown in Brass

Available colors: B



LOUIS XV

HBP0024

4 3/4" L x 2 3/4" D

Shown in Brass

Available colors: B



SCEPTRE

HBP0244

4 1/2" L x 2 1/2" D

Shown in Brass

Available colors: A, B

CREATE YOUR FINIALS WITH PIECES IN BRASS OR NICKEL!

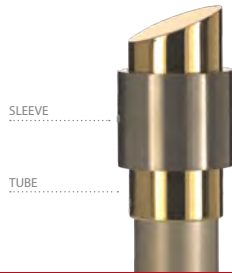

Expo

HBA0414

4" L x 2 1/8" D

Combination shown:

Tube in Brass, Sleeve in Nickel (BN)

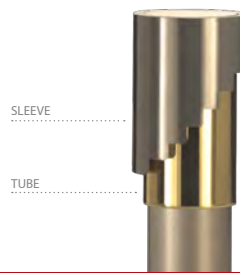

ESCALA II

HBA0404

3 1/2" L x 2 1/8" D

Combination shown:

Sleeve in Nickel, Tube in Brass (NB)



OLYMPIC

HBA0424

3 1/2" L x 2 1/8" D

Combination shown:

Tube in Nickel, Rings in Brass (NB)

AVAILABLE COLORS

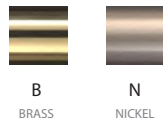

B

BRASS

N

NICKEL

RODDING



HBT3004 - BRASS TUBE

- ALL MEASUREMENTS MUST BE FOR ROD LENGTH ONLY.
- MAXIMUM LENGTH FOR A SINGLE ROD IS 96".
- AFTER 84" A CENTER SUPPORT IS REQUIRED.
- RODS GREATER THAN 96" WILL BE SHIPPED IN 2 EQUAL PIECES.

SUPPORTS

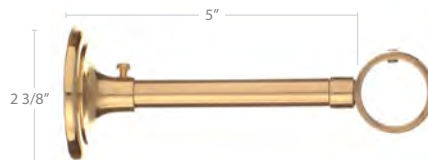

HBP6274 — SUPPORT 5"

HBP6284 — CENTER SUPPORT 5"

OPTIONAL PRODUCTS



HBP5824

RING 82

Use Ring Clip 83 (sold separately)



HBP5830

RING CLIP 83



HBP4766

TUDOR TIEBACK
Available color: B



HBP4764.AL (LEFT)

HBP4764.AR (RIGHT)

MEDICI TIEBACK
Available color: A



HBP4772 - 2"
HBP4774 - 3 3/8"
HBP4776 - 6"
BRAVA HOOK

Available colors: B, N



HBP4782 - 2"
HBP4786 - 6"
LIBERTY HOOK

Available color: A



HBP4792 - 2"
HBP4794 - 4"
HBP4796 - 6 3/4"
LOUIS HOOK

Available color: A



HBP4751 - 1"
HBP4752 - 1 1/2"
HBP4754 - 2"
TRADITIONAL HOOK

Available color: A

ARTFIL • THE ART OF SUSPENSION

ALL KITS COME WITH 10 FEET OF WIRE.
THERE IS NO EXTRA CHARGE FOR WIRE LENGTHS UP TO 16 FEET (MUST BE REQUESTED).

AVAILABLE COLORS



B
BRASS



N
NICKEL

OPTIONAL PRODUCTS



HBP0450
CLASSIQUE CENTER SUPPORT



HBP5400
S-HOOK



HBP0350
BOLLA CENTER SUPPORT

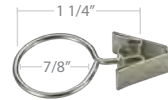

HBP5280
RING WITH PINCH CLIP



ARTFIL CLASSIQUE

KIT EQUERRE - HBA9542
WALL OR CEILING INSTALLATION (CENTER SUPPORT NOT INCLUDED)
Center support is required for lengths greater than 72"

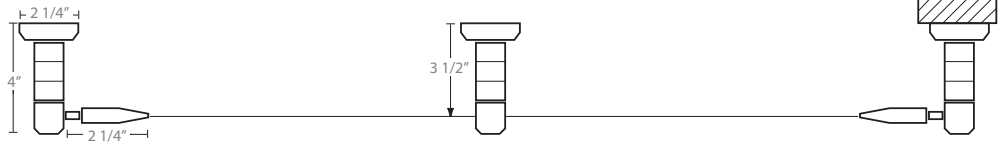

KIT CONIQUE - HBA9543
INSIDE WALL MOUNT INSTALLATION
Center support is required for lengths greater than 72"

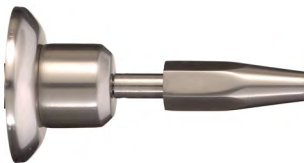

ARTFIL BOLLA

KIT EQUERRE BOLLA - HBA9433
WALL OR CEILING INSTALLATION (CENTER SUPPORT NOT INCLUDED)
Center support is required for lengths greater than 72"

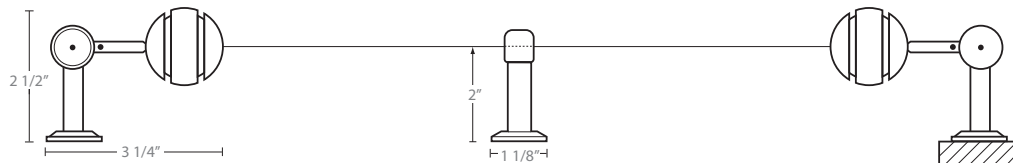

KIT CONIQUE BOLLA - HBA9432
INSIDE WALL MOUNT INSTALLATION
Center support is required for lengths greater than 72"



ORDER ONLINE IN SIX EASY STEPS

WWW.CLAIREDECO.COM

1 Log in or if it is your first time, create an account here

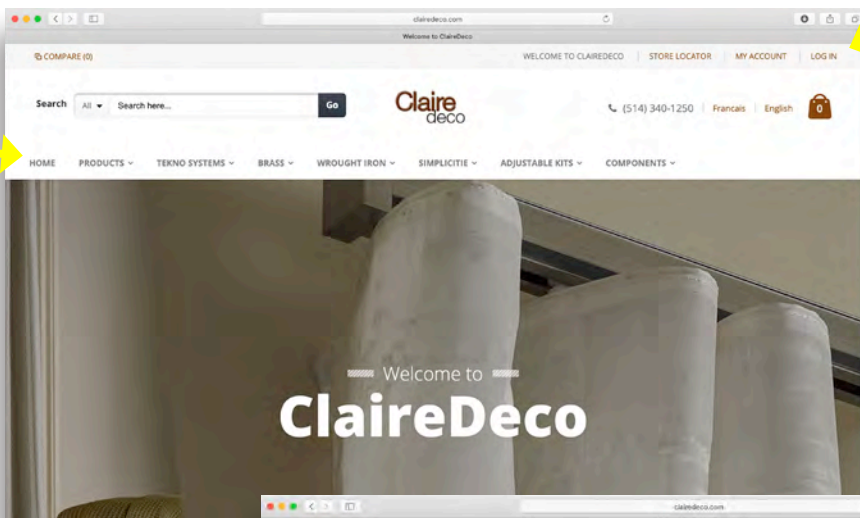

2 Pick a product

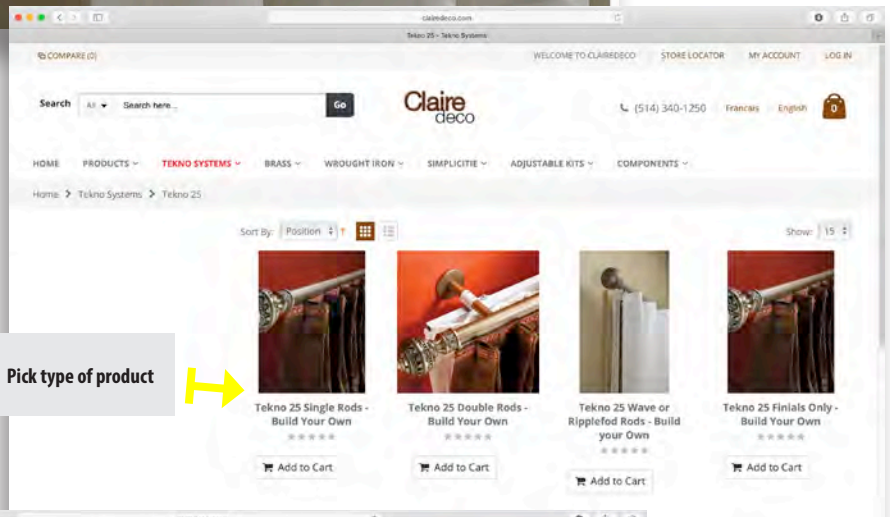

3 Pick type of product

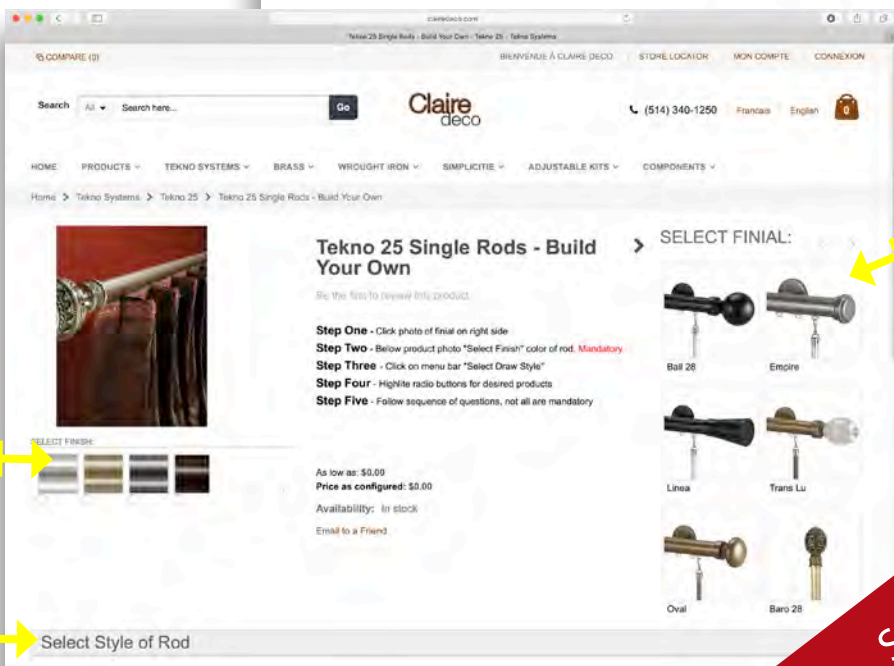

4 Pick finial

5 Select Finish

6 Select rod style and then following options as desired

SAVE 10%
ON THE FIRST TWO
ONLINE ORDERS IN 2019**
USE CODE: ON19 AT CHECKOUT



Midwest
Designer
Supply

www.midwestdesignersupply.com

888-523-2611
262-524-1007 (fax)